



promo scuole '21

HOLZHOFF® 

playground & urban equipment

CAM – Criteri Ambientali Minimi

Prodotti disponibili conformi al Decreto CAM – Criteri Ambientali Minimi per l'acquisto di articoli per l'arredo urbano e giochi in robinia certificata FSC® oppure PEFC™, alluminio e polietilene riciclato.

Le immagini pubblicate hanno il solo scopo di illustrare il prodotto nella sua interezza. La direzione si riserva il diritto di apportare in qualunque momento e senza preavviso migliorie e/o modifiche tecniche oppure estetiche a tutti gli articoli presenti nel catalogo, nonché di fornire gli stessi in colori/combinazioni cromatiche diverse da quelle divulgate, per ragioni tecniche, estetiche o semplicemente di disponibilità di scorte e/o di magazzino.

Non tutte le strutture ludiche, sebbene realizzate in conformità con la normativa UNI EN 1176 in vigore, sono certificate dall'Ente Tüv Product Service (Germania) o dal TÜV Italia S.r.l.

Mercato online

Siamo presenti sulle principali piattaforme di acquisti in rete:

MEPA CONSIP:	Portale Acquisti Pubblica Amministrazione su tutto il territorio nazionale
ME-PAT:	Acquisti on-line della Pubblica Amministrazione Provincia Autonoma di Trento
ME-PAB:	Sistema Informativo dei Contratti Pubblici Provincia Autonoma di Bolzano
SINTEL E-PROCUREMENT:	Sistema Intermediazione Telematica Regione Lombardia
INVA:	Centrale unica Committenza Regione Autonoma Valle D'Aosta (ME.VA)
CEV:	Acquisti Centralizzati Consorzio Energia Veneto
INTERCENT-ER:	Acquisti telematici Regione Emilia-Romagna
eAPPALTI FVG:	Portale d. stazioni Appaltanti Regione Friuli Venezia Giulia
START:	Sistema Telematico Acquisti Regionale Toscana
SIGEME:	Sistema Informativo per la Gestione del Mercato Elettronico Città di Firenze
EMPULIA:	Acquisti on-line della Pubblica Amministrazione Regione Puglia
ASMECOMM:	Centrale di Committenza Enti Associati
SARDEGNA CAT:	Centrale Regionale di Committenza

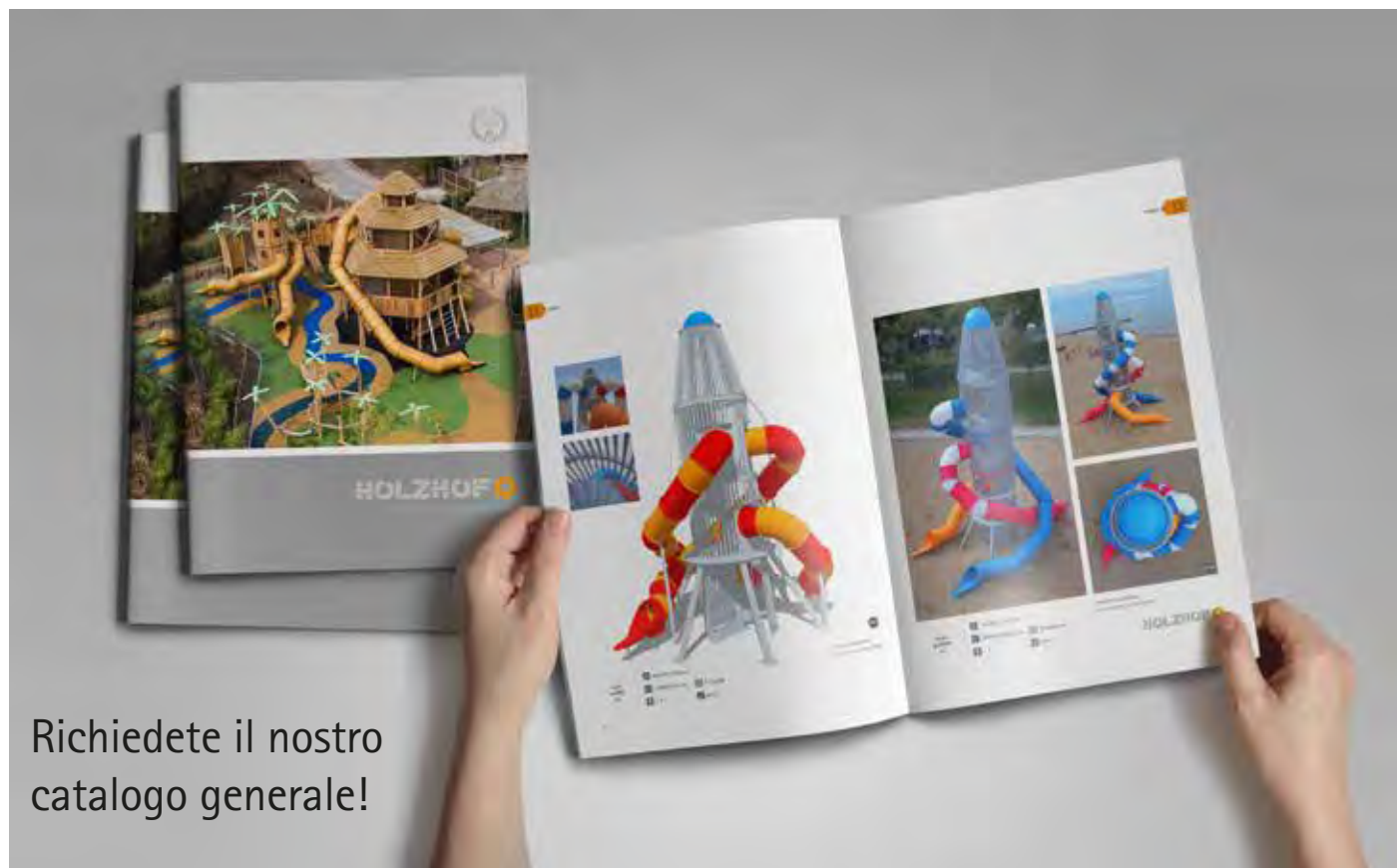

Richiedete il nostro catalogo generale!



■ cassette	4
■ giochi statici	6
■ acqua e sabbia	11
■ scivoli 2/8	15
■ strutture combinate	16
■ eldorado	22
■ strutture a tema	23
■ giochi a rete	28
■ fit & fun	30
■ altalene	41
■ giochi a molla	44
■ tavoli e panche	53
■ urban design	56
■ pavimentazione in gomma	60
■ linea fantasy	62
■ profilo aziendale	70
■ materiali	71

Edizione 1/2021 - Copyright© Holzhof Srl
 Holzhof Srl - Via Rupe, 33 - I-38017 Mezzolombardo, TN
 Fon + 39 0461 601 501 - Fax +39 0461 604 013
 info@holzhof.com - www.holzhof.com

Concept, copy and design: media-forum.it
 Photo: Holzhof, allesfoto.com, istockphoto.com,
 Gregor Khuen Belasi
 Printed by: Grafiche Stella, Verona

casette



new

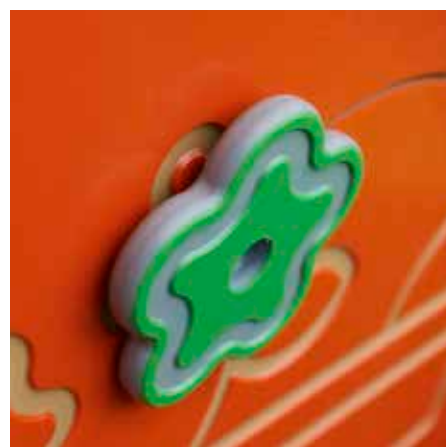
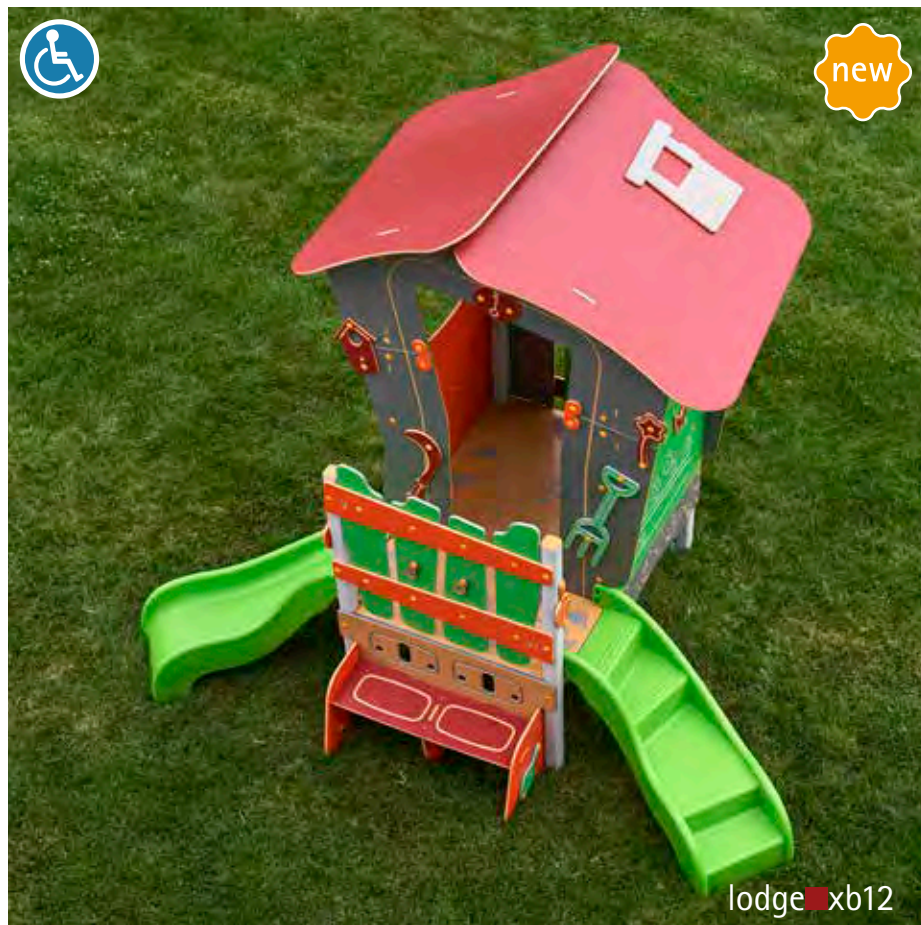

lodge xb12



cottage xs12

HOLZHOFF



new

Design
& Quality
Made in Italy

farmxb10



new

playfarmxb15



HOLZHOF®





pallottoliere xpa12



arcobaleno xpa13



shop xpa14



paper/stone xpa15



Design
Et Quality
Made in Italy

trenino ■ xu67/68/69



vagone tunnel ■ xu69



vagone passeggeri ■ xu68



locomotiva ■ xu67

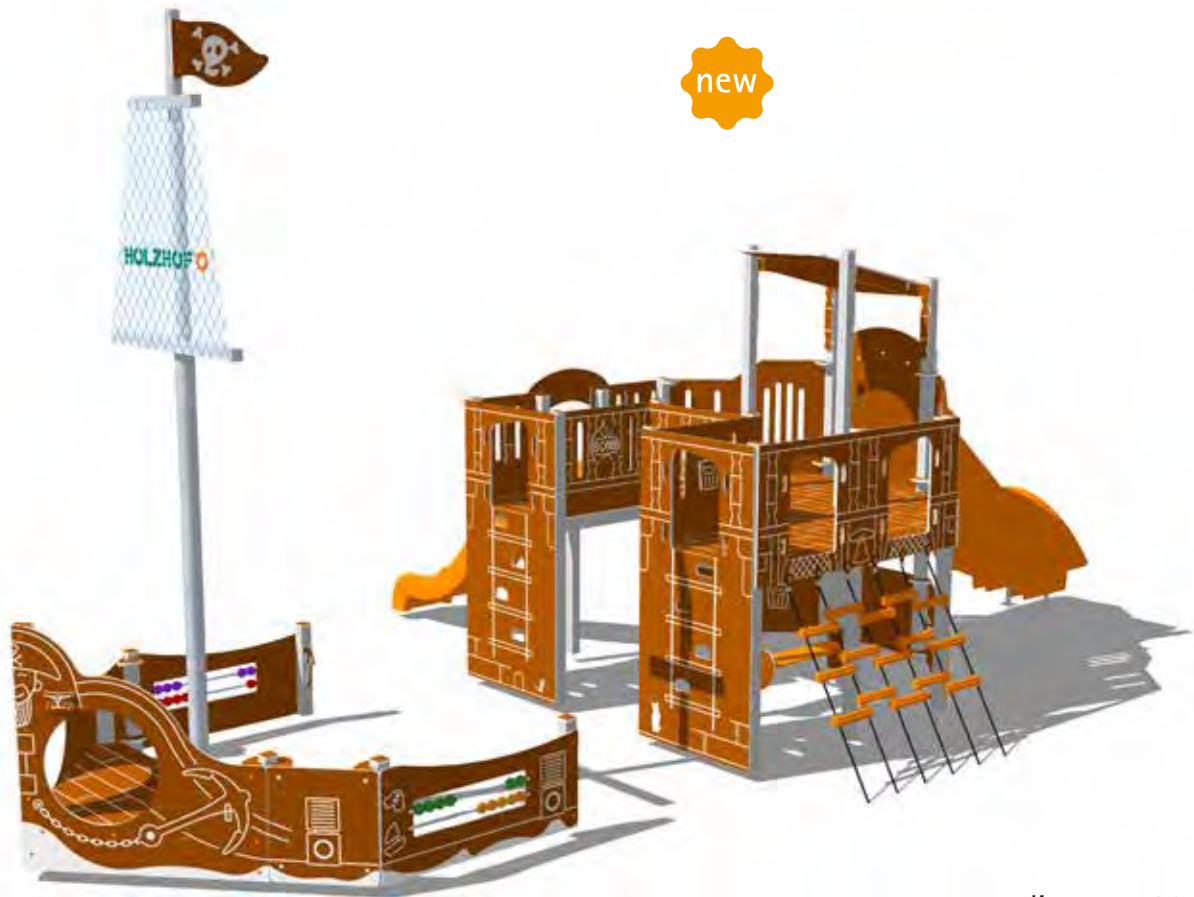

new

veliero xo68 alu



new

pescherello xo64 alu



tunnel 130 xp19

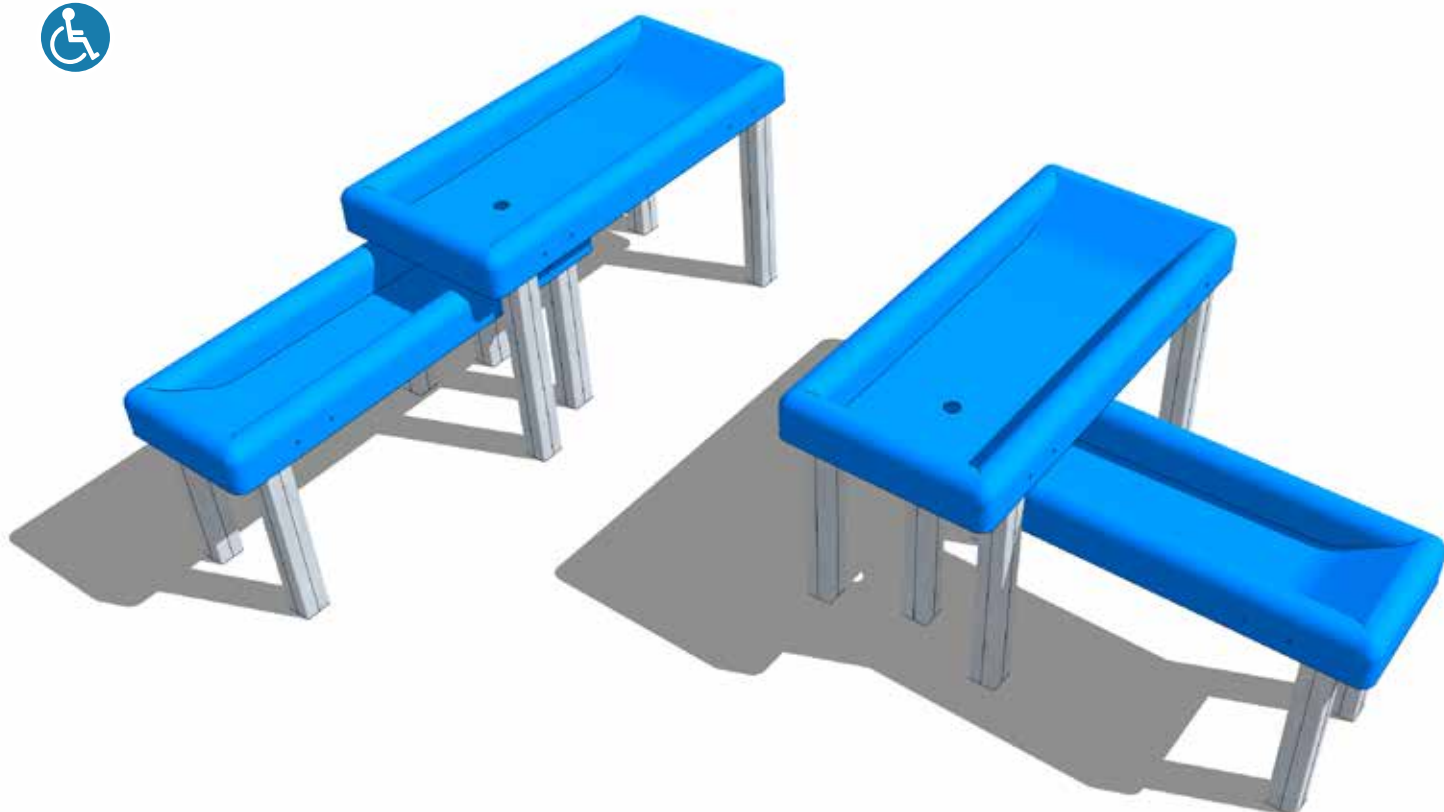

acqua e sabbia xp28b alu



togy■xps15



acqua e sabbia■xp28r alu + xp09b



fontana■xp09b



tavolo kitchen ■ xpm15r



tavolo kitchen ■ xpm15v



new

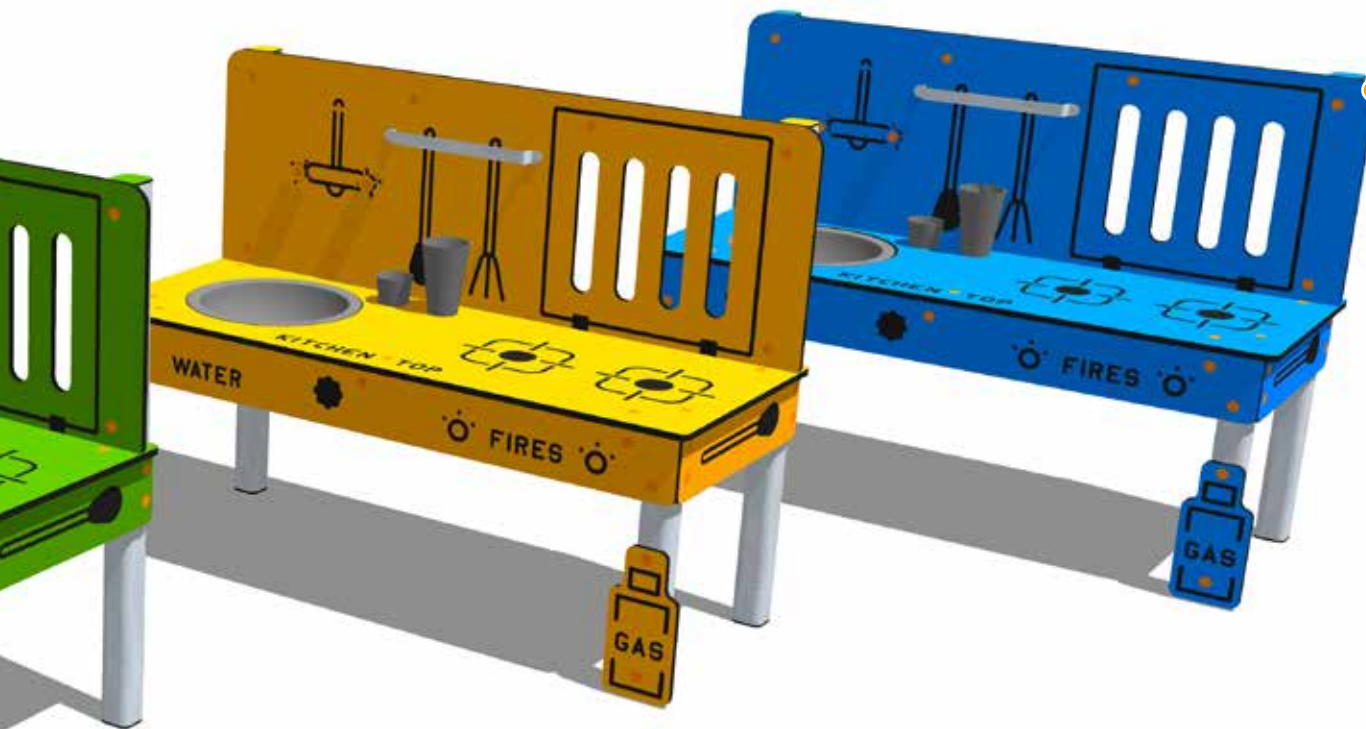

tavolo kitchen xpm15g

tavolo kitchen xpm15b





tavolo di manipolazione xp13



tavolo spinner xp08



dumby xfa20 PE



terry xfa15 PE

strutture combinate



aladin xre80

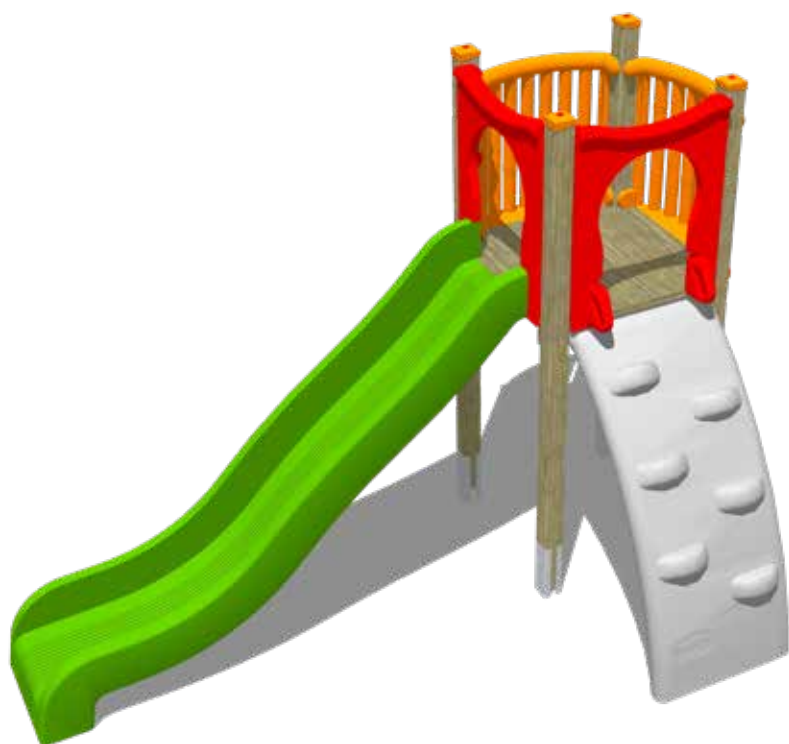

aladin xre144



aladin xa100r



aladin■xa480



max■xm104



Design
& Quality
Made in Italy

aladin ■ xa205r alu



oxi ■ xoxi202 alu



oxi xoxi100



oxi xoxi700



kaluba xka112



kaluba xkn300

new



indianxi100 alu

new



indianxi200 alu



Design
& Quality
Made in Italy





tino xt110

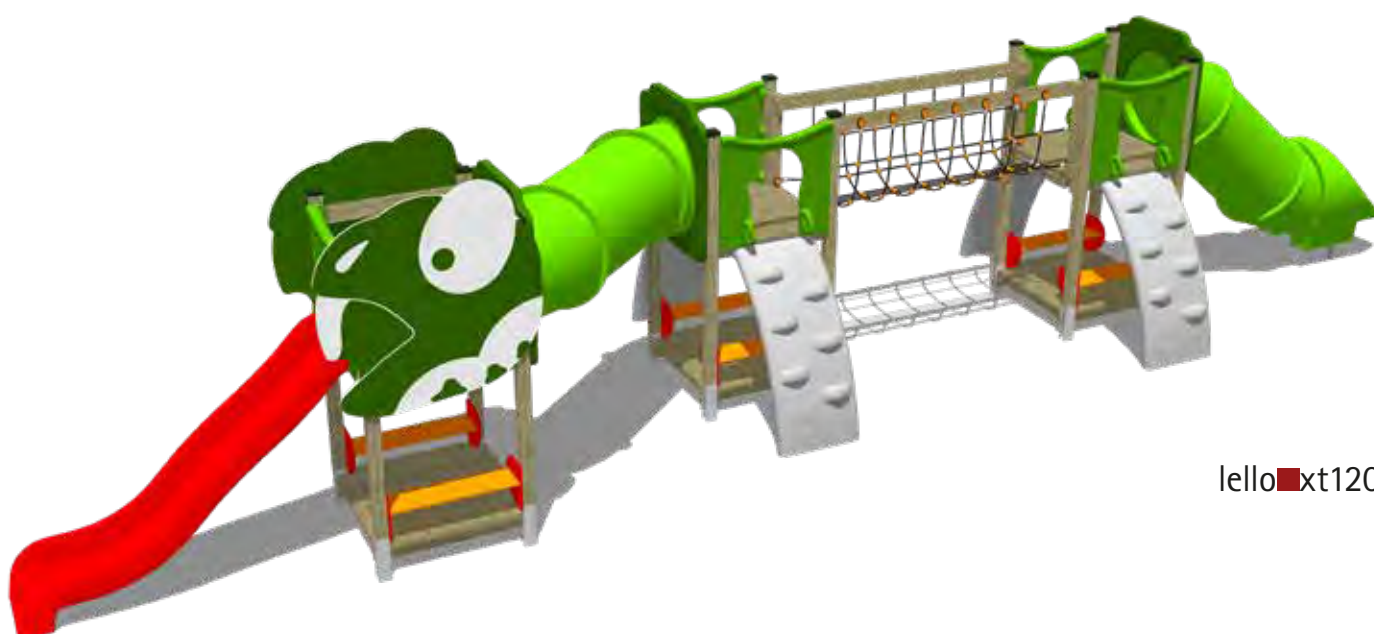

lello xt120

strutture a tema



castello dirondello ■ xt100



stazione ■ xt95



torre king ■ xt150t

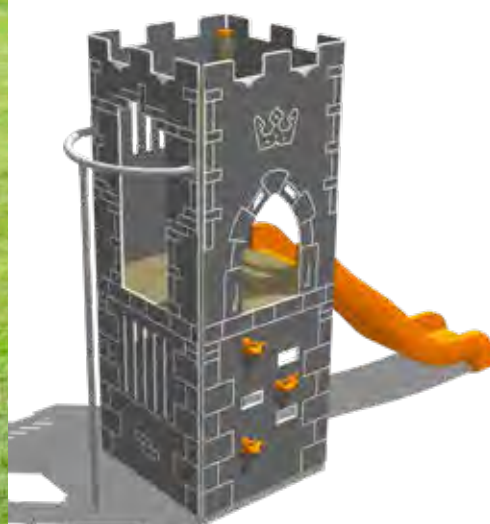

torre king ■ xt150

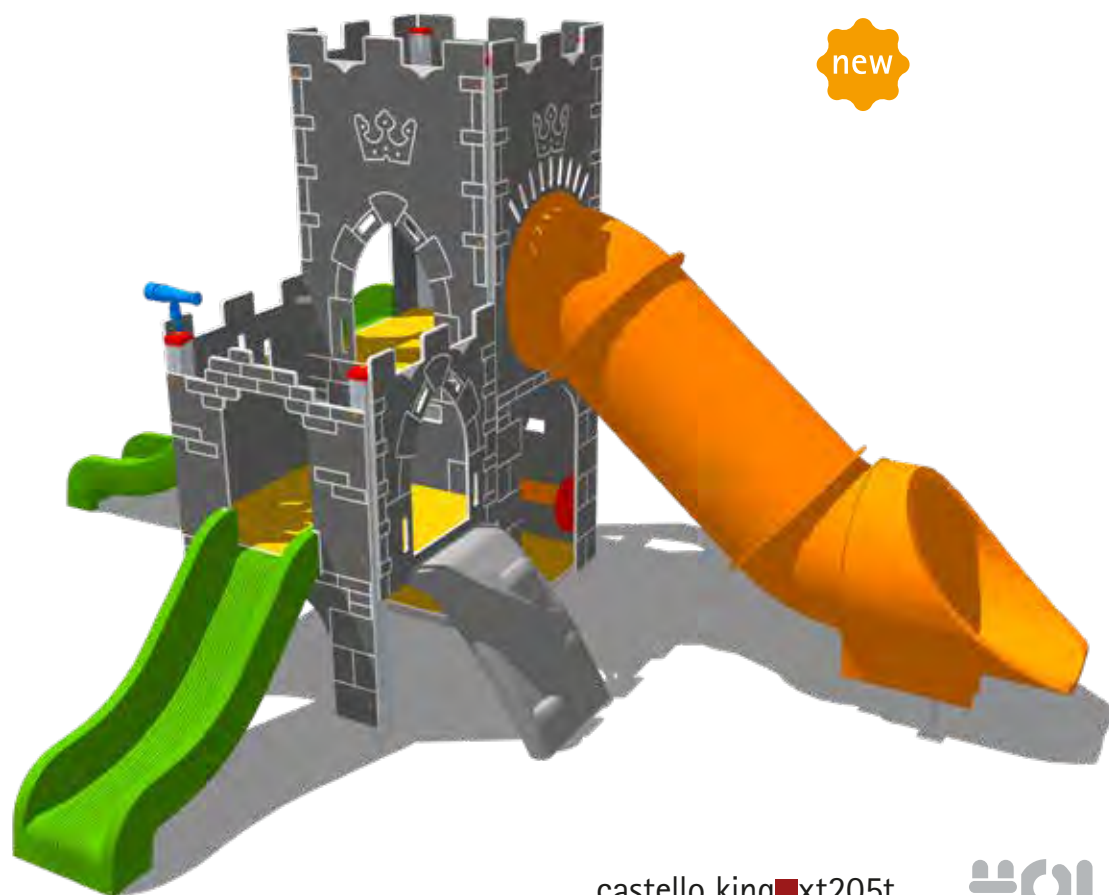

new

castello king ■ xt205t

strutture a tema



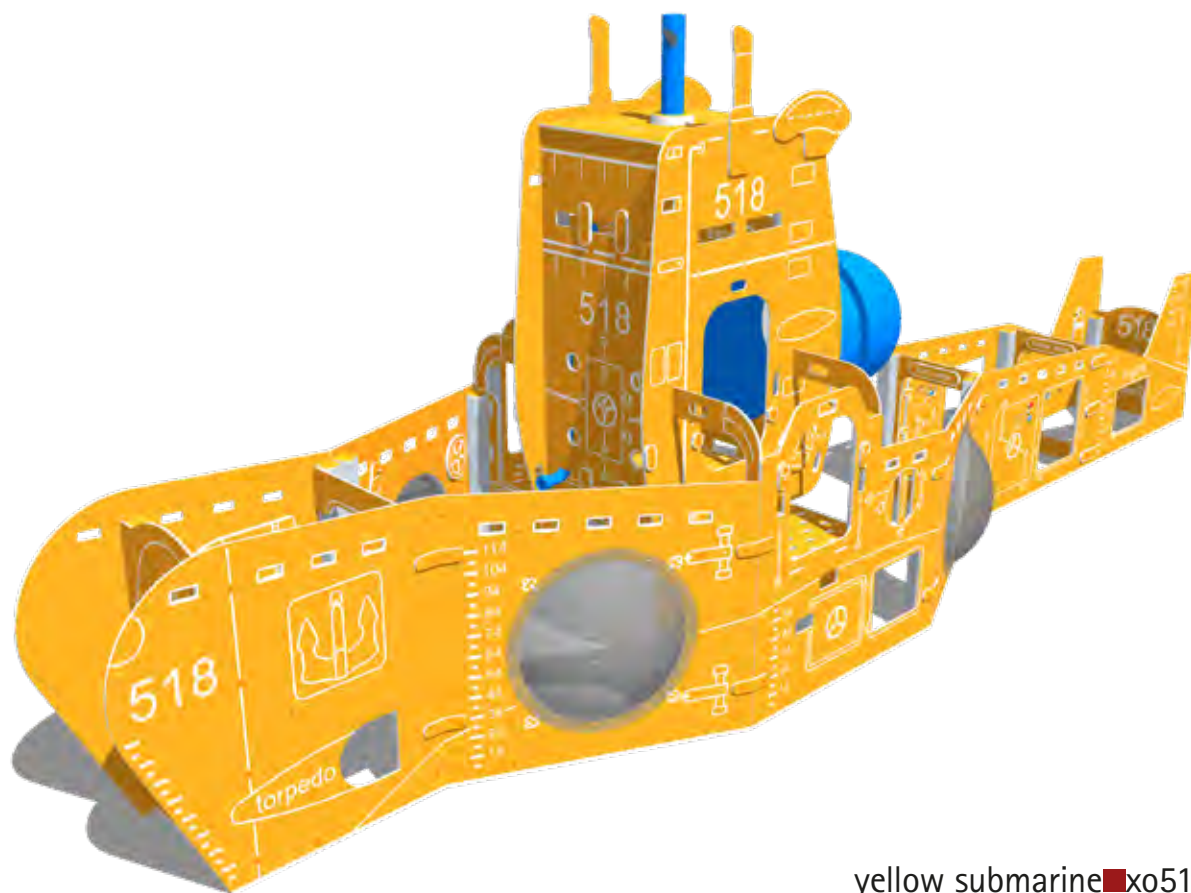

yellow submarine ■ xo51g

Design
& Quality
Made in Italy

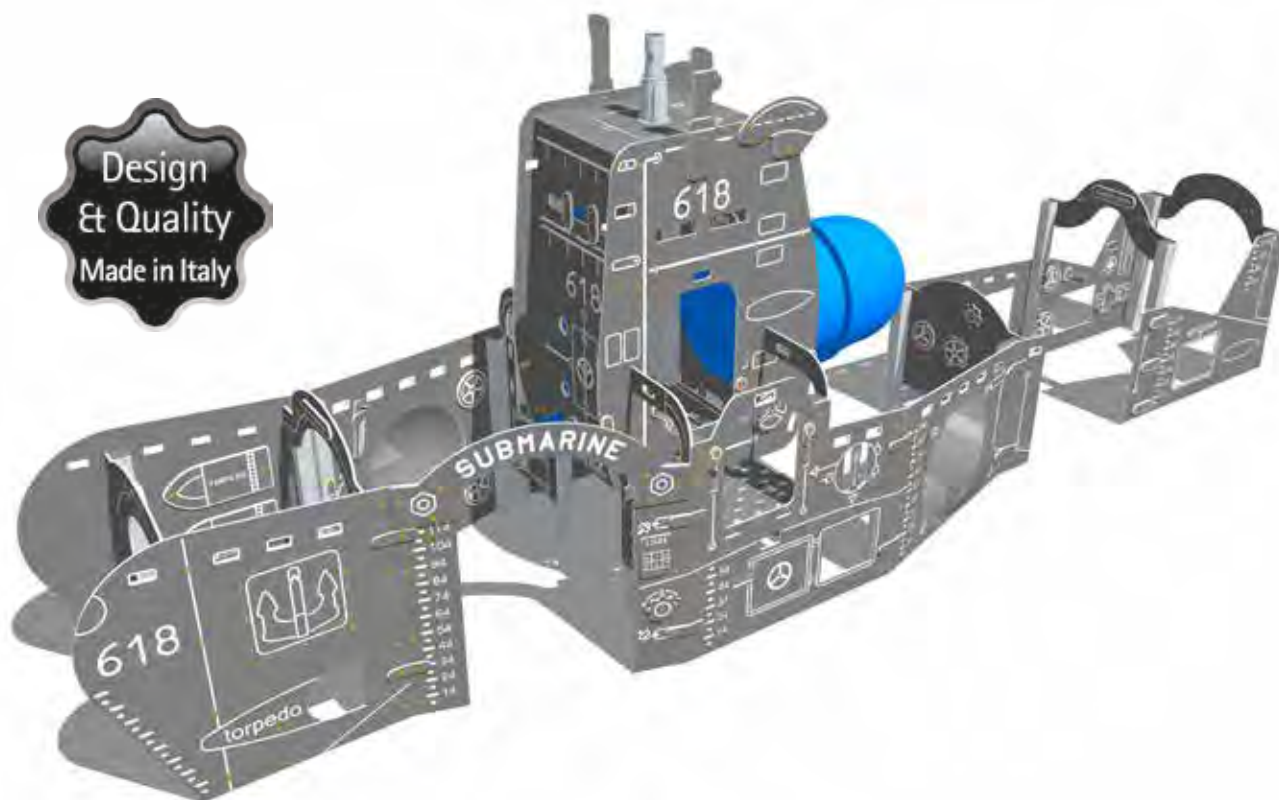

submarine ■ xo40

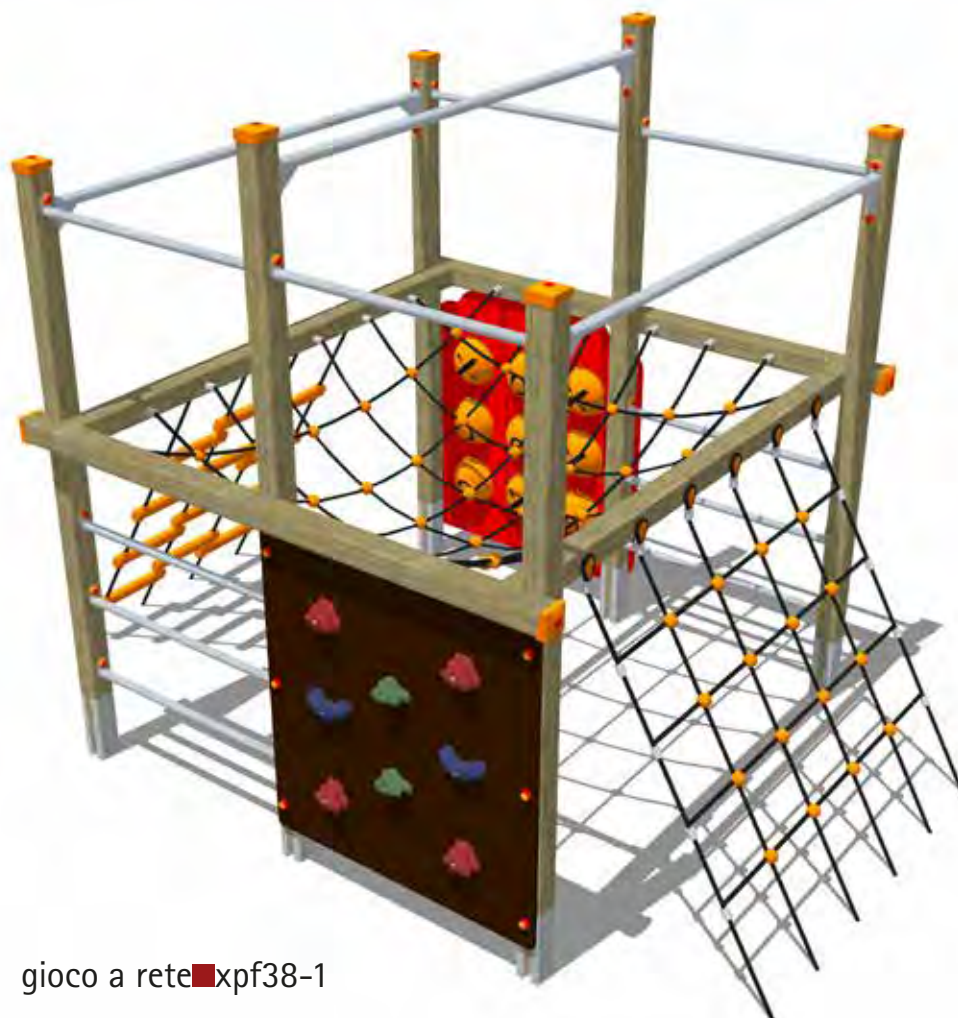

gioco a rete ■ xpf38-1

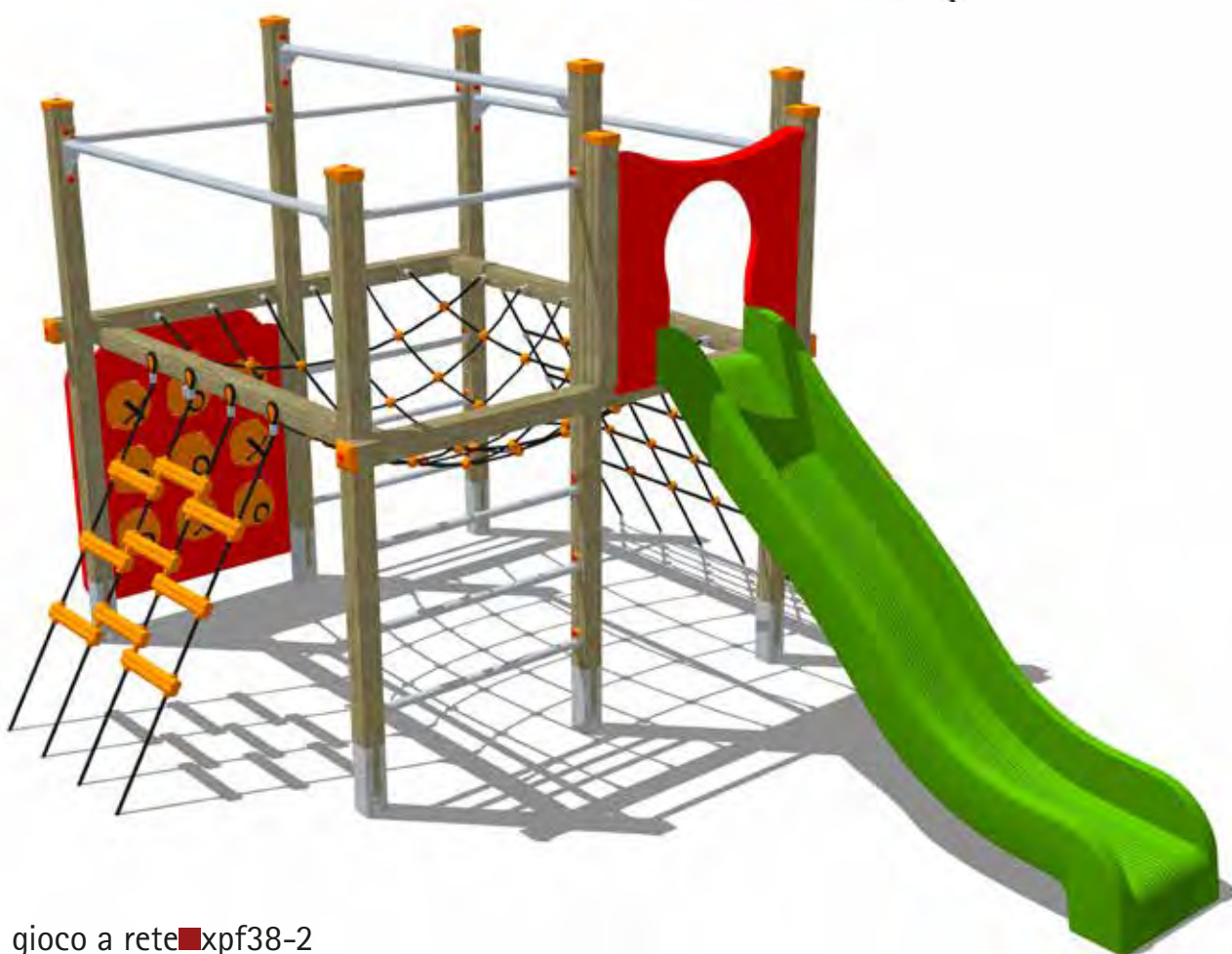

gioco a rete ■ xpf38-2

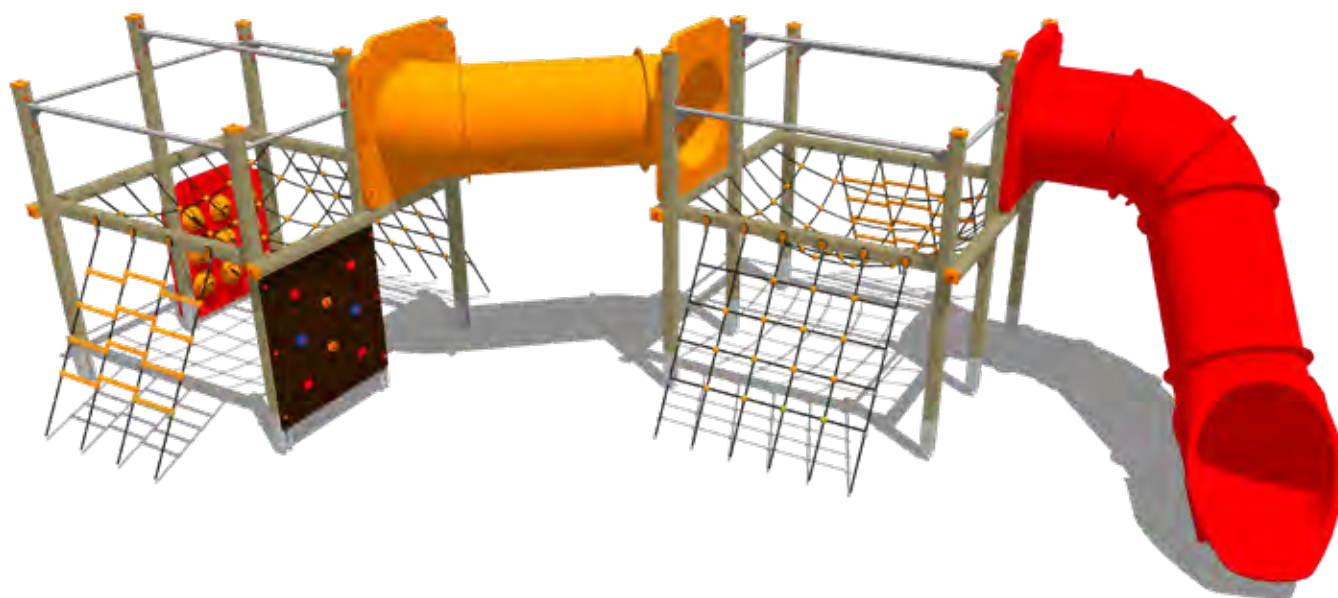

HOLZHOF®

gioco a rete xpf39-1

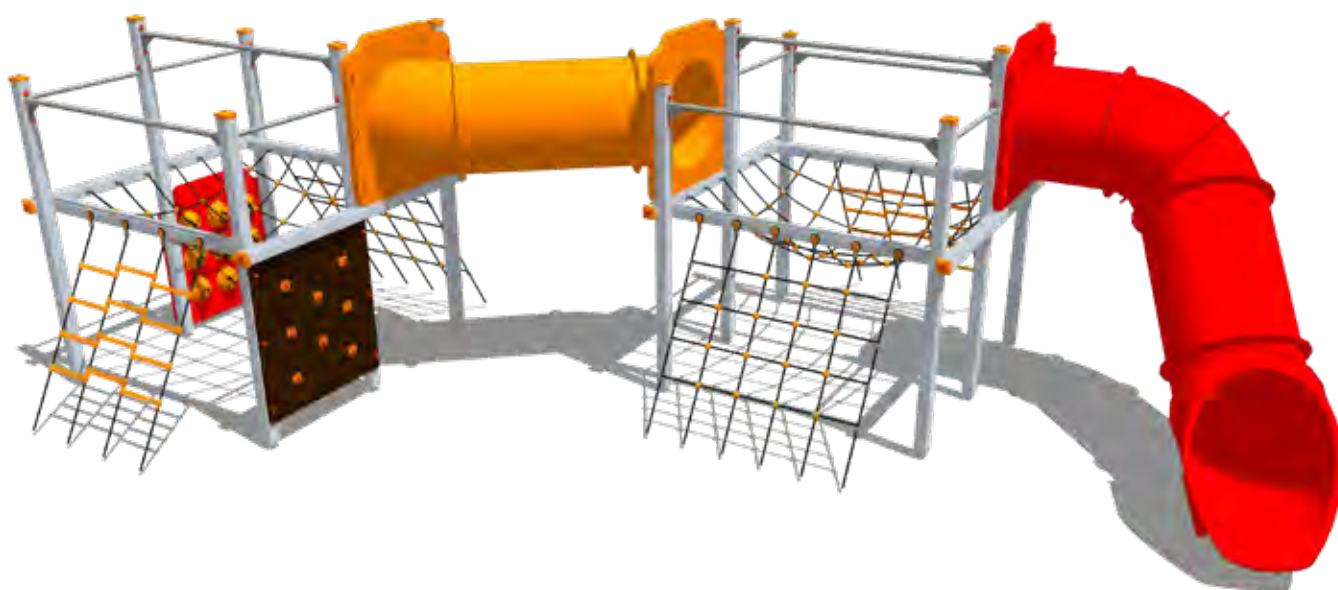

gioco a rete xoxi39-1



composizione ginnica ■ xsp240





step■xsp163



training station■xsp164

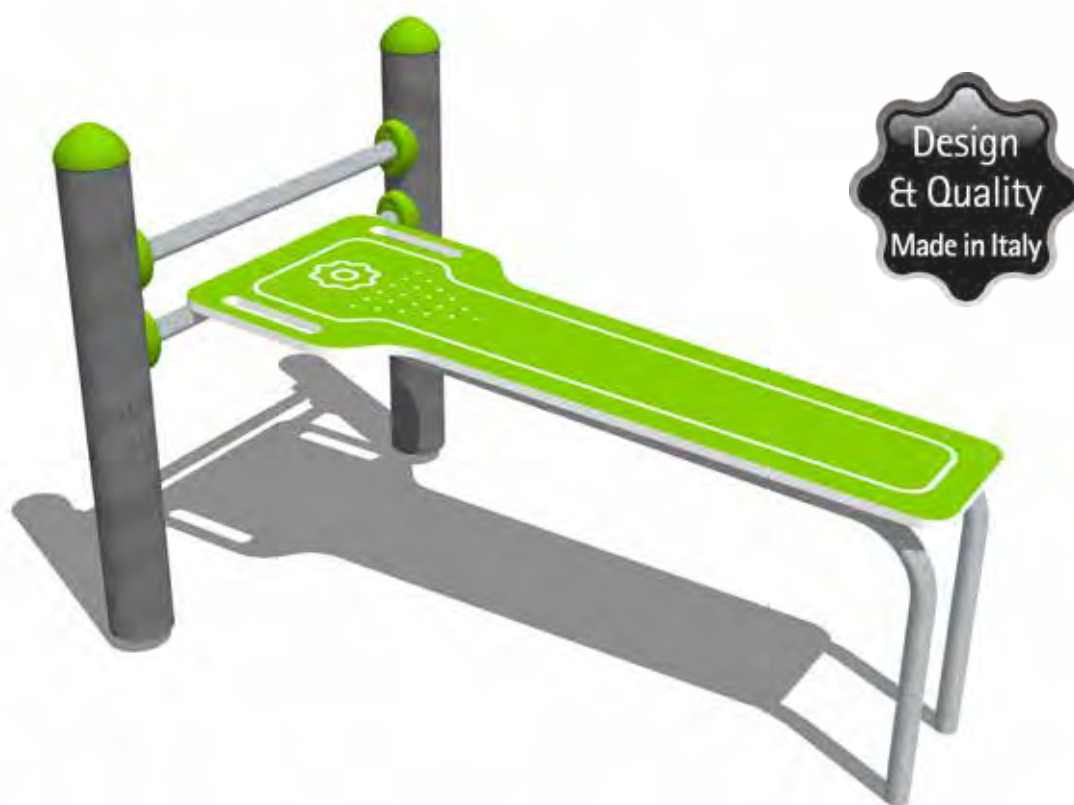

Design
& Quality
Made in Italy

panca xsp161

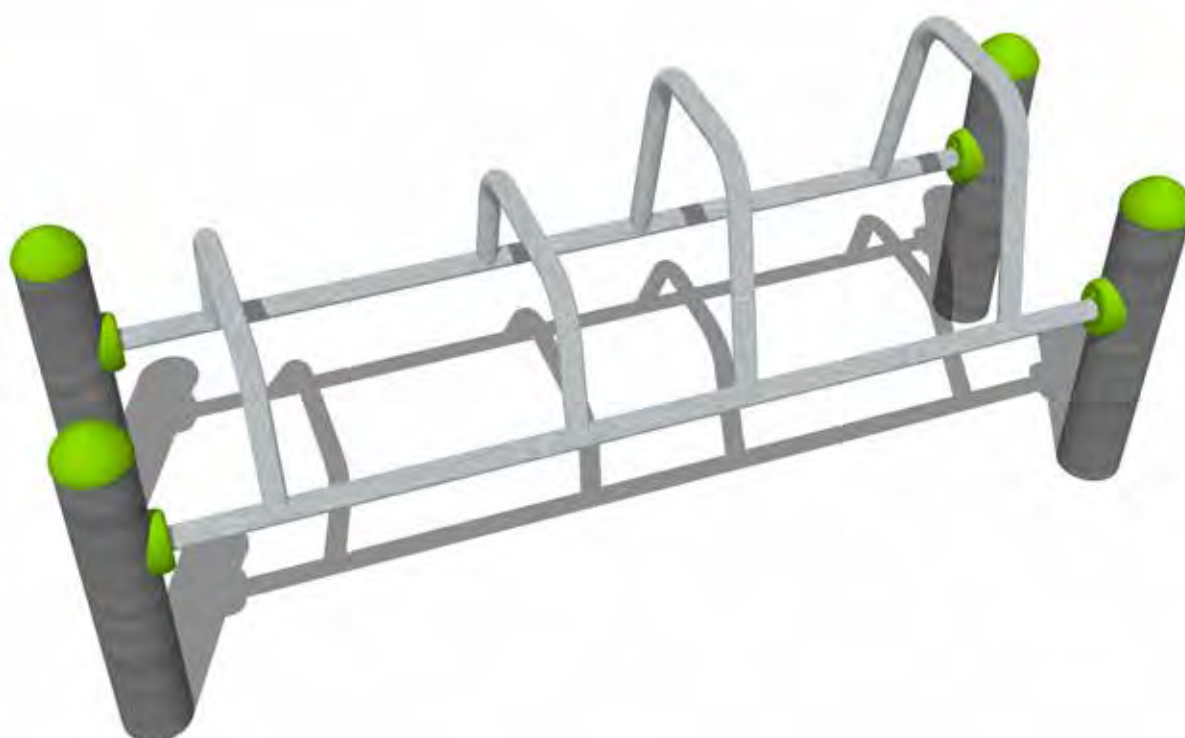

tricipiti xsp162





pull up castle ■ xsp165



spalliera verticale ■ xsp166

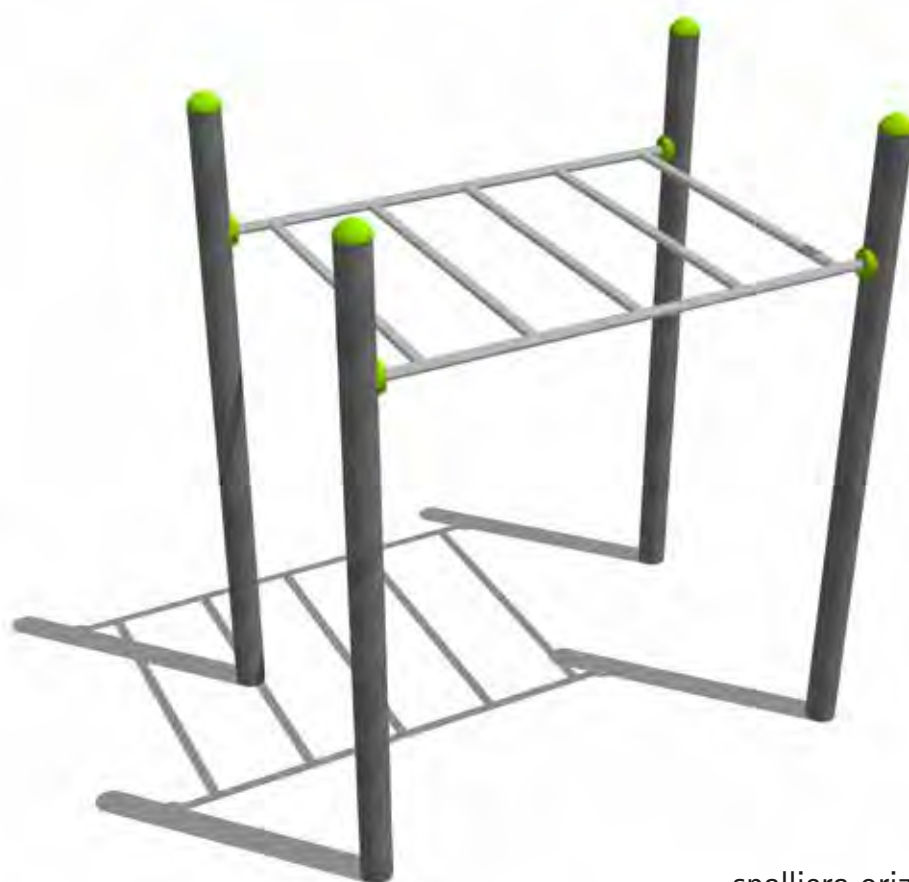

spalliera orizzontale ■ xsp167



parallele ■ xsp168

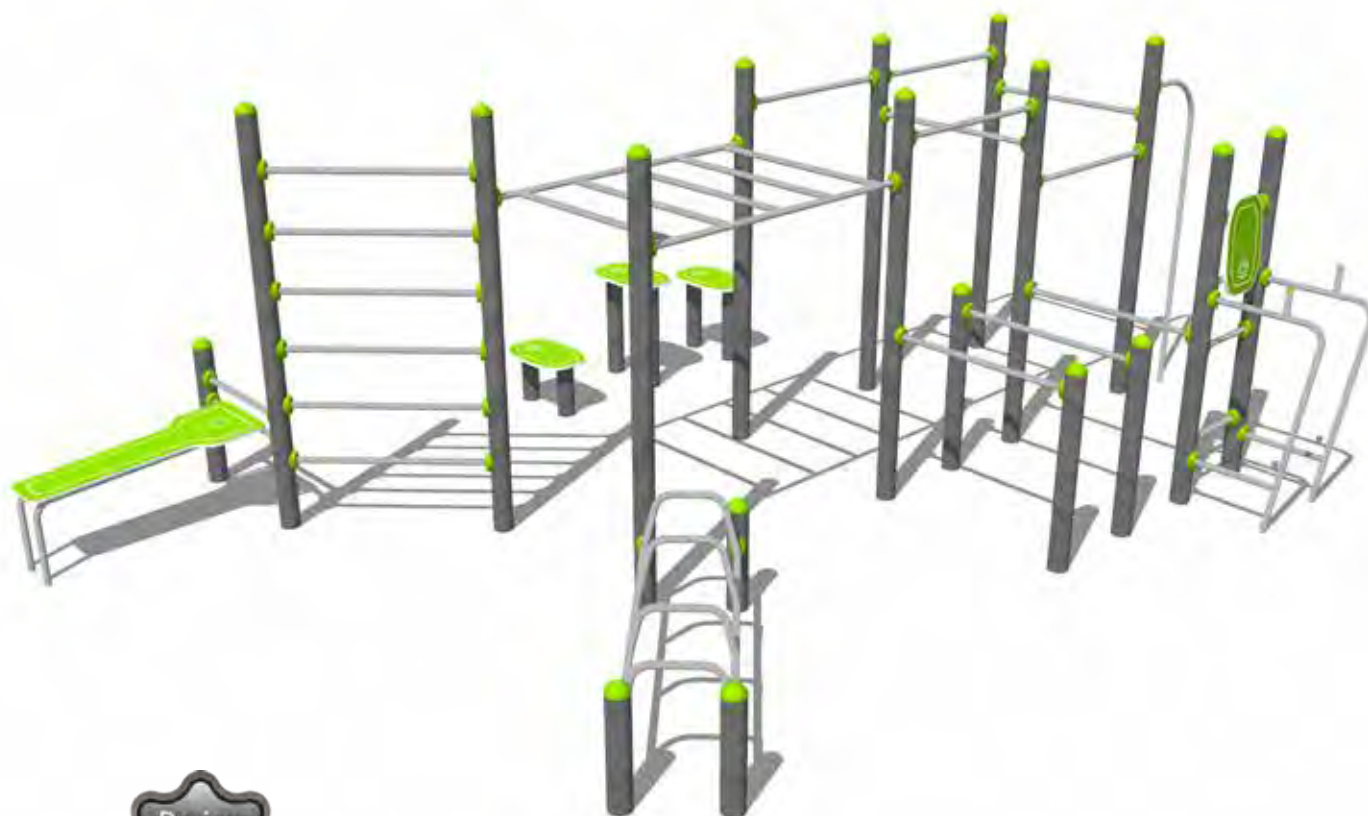

Design
& Quality
Made in Italy

calisthenics xsp460

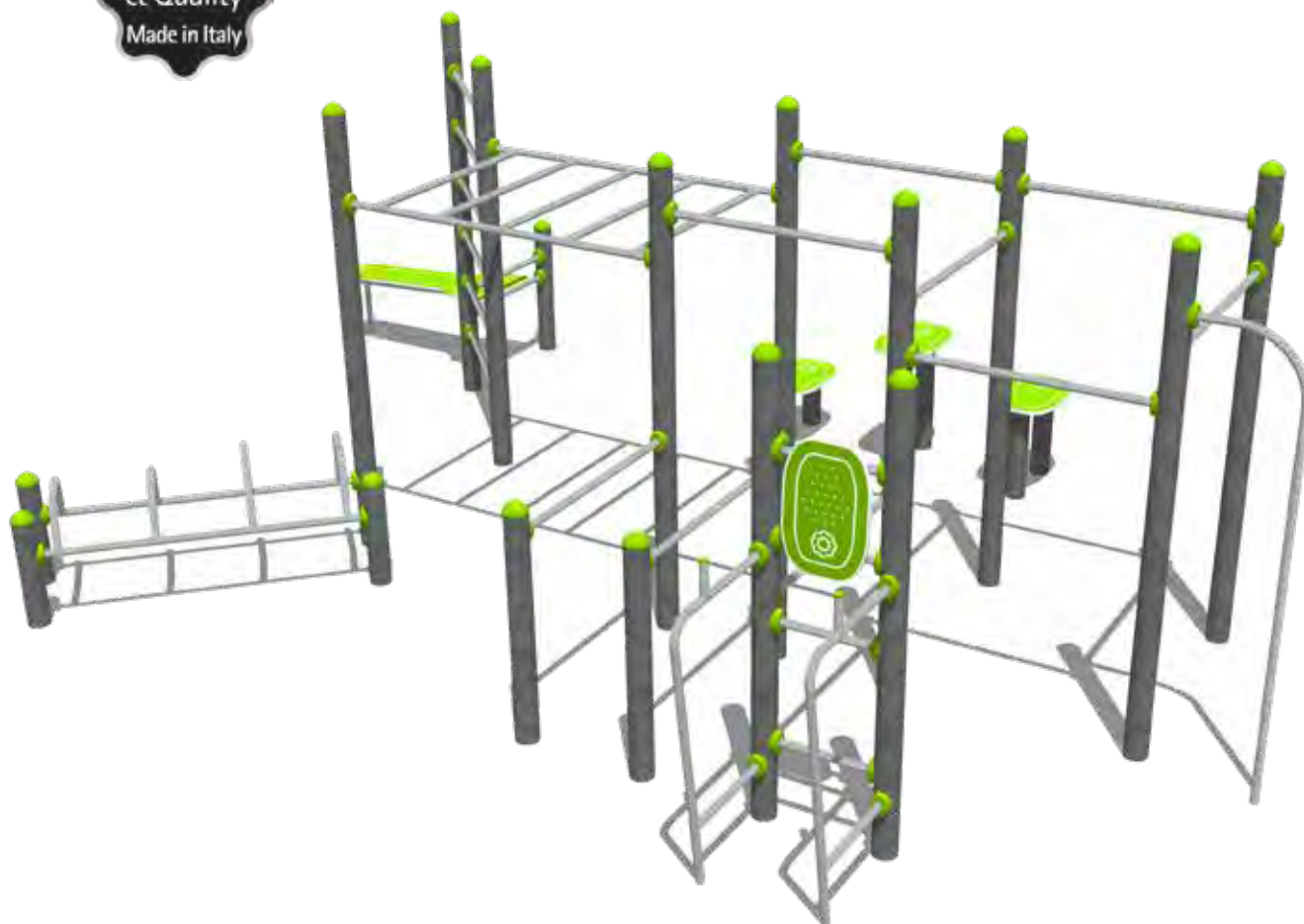



senior parc xsp285





cavalletto xcar11



cavalletto xcar10



cavalletto xcar20



cavalletto xcar21



HOLZHOF®





porta da calcio 2,16x1,62 xspc2



porta da calcio 3x2 xspc3



porta da calcio 5x2 xspc5



porta da calcio 7,32x2,44 xspc7



sultan xsal45

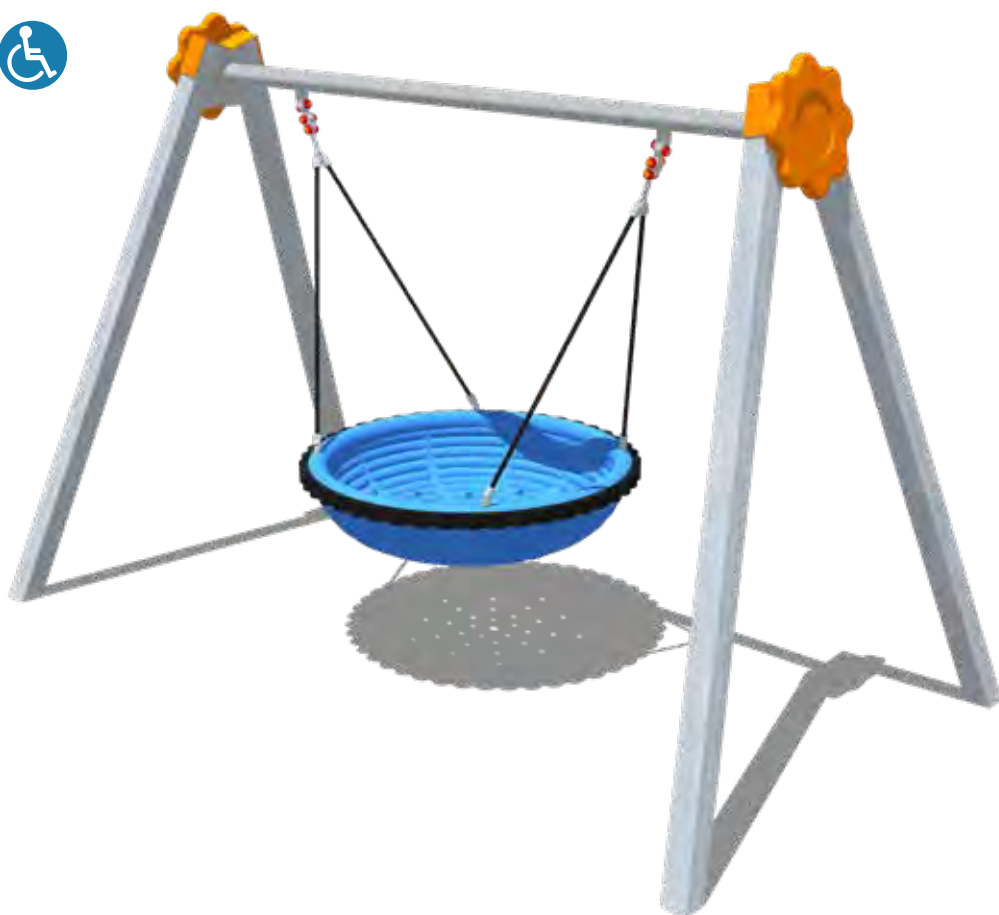

oxi xoxia43

altalene

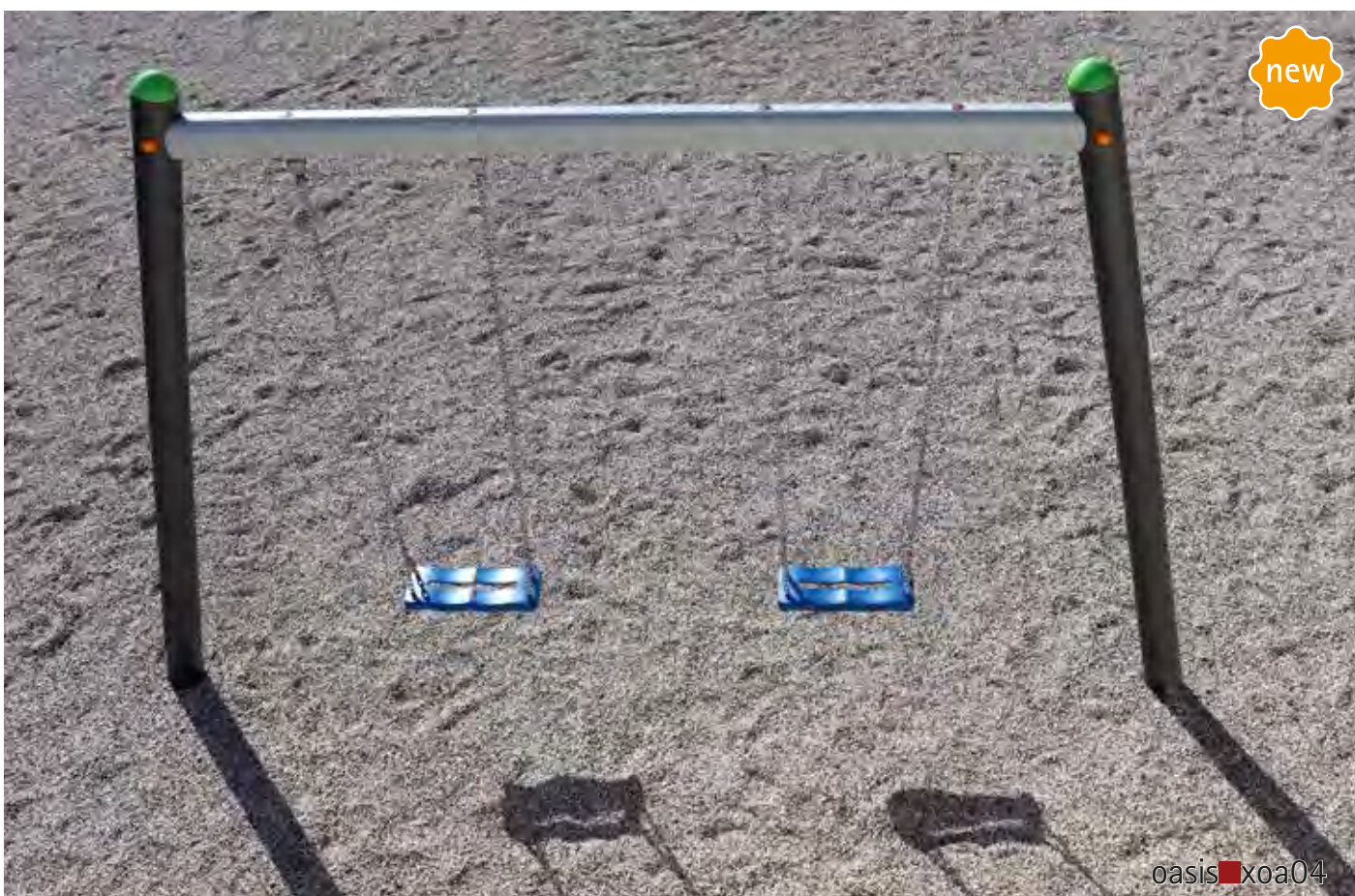



oxi xoxia41



sultan xsal41



HOLZHOF®





flippy xom8



vespy xum16



moto xum1







buggy xum134



fiorellino xflm121



candy xflm130



three wheels xum133





cross xum40

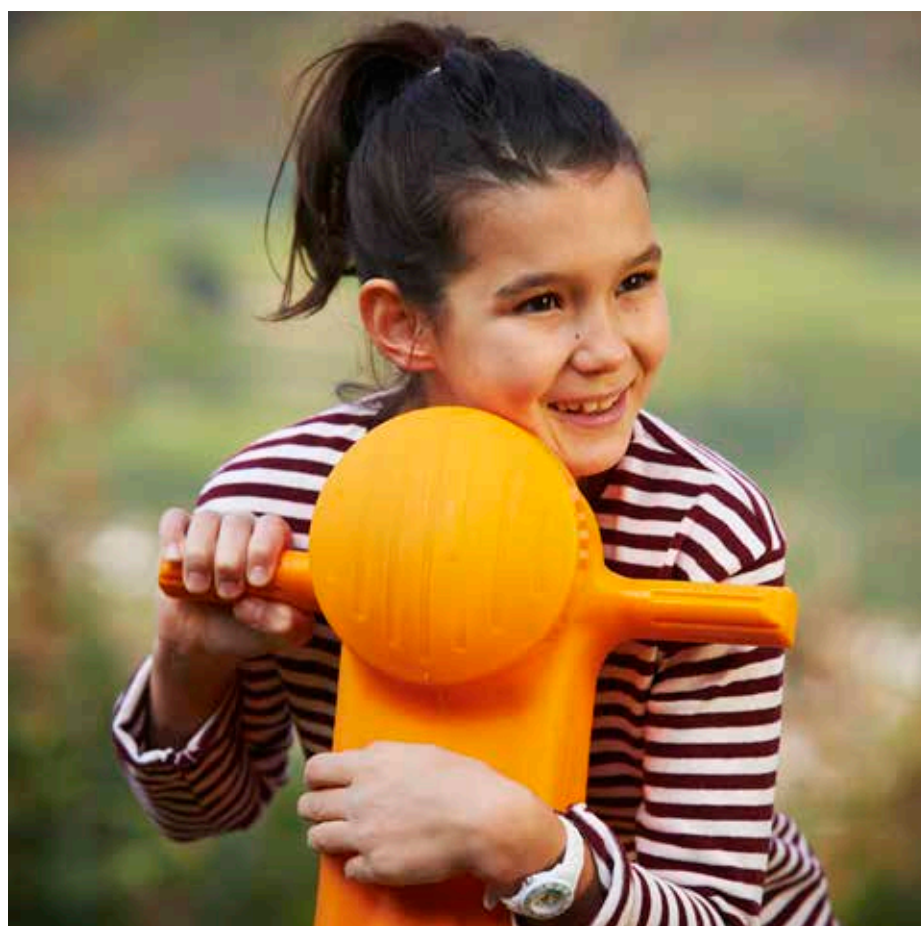





comunica4  com4

HOLZHOF 



comunica8  com8





pausa bimbi ■ xc35



pic-nic bimbi ■ xc29



happy4 ■ xfl60



relax ■ prb150

Design
& Quality
Made in Italy



volta ■ va225



mini arena ■ ma500



mini arena ■ ma600



composizione royal ■ xpr300



trono ■ xpt150b



trono ■ xpt150r



panca ■ xpp200



big bobo xp54 eco



recycling cdf01



pavimentazione



Grazie all'utilizzo della pavimentazione in gomma Playlastic® anche il terreno può diventare un'area di gioco sicura e divertente, su cui muoversi liberamente.

Caratterizzata dall'assenza di barriere architettoniche, questa pavimentazione è adatta anche per i bambini portatori di handicap o costretti a muoversi su carrozzina.

La nostra azienda è in grado di fornire e di mettere in opera il pavimento antitrauma in colato, spessore mm 30/50 o 70 o altri spessori in funzione dell'altezza di caduta, posato in continuo senza giunture su una base di sottofondo in cemento.

Pavimentazione realizzata in doppio strato di densità e granulometria differenziata e composta miscela di granuli di gomma SBR e resina legante poliuretanicca monocomponente posata con 1° colata in granuli neri e successiva stesura superficiale con granuli colorati in EPDM puro, lisciata con spatole metalliche, con caratteristiche di alta resistenza all'usura ed agli agenti atmosferici.

Playlastic® non richiede particolari interventi di manutenzione ed è atossica. La stessa è stata sottoposta alle prove per determinare l'attenuazione di impatto secondo le norme UNI EN 1177.

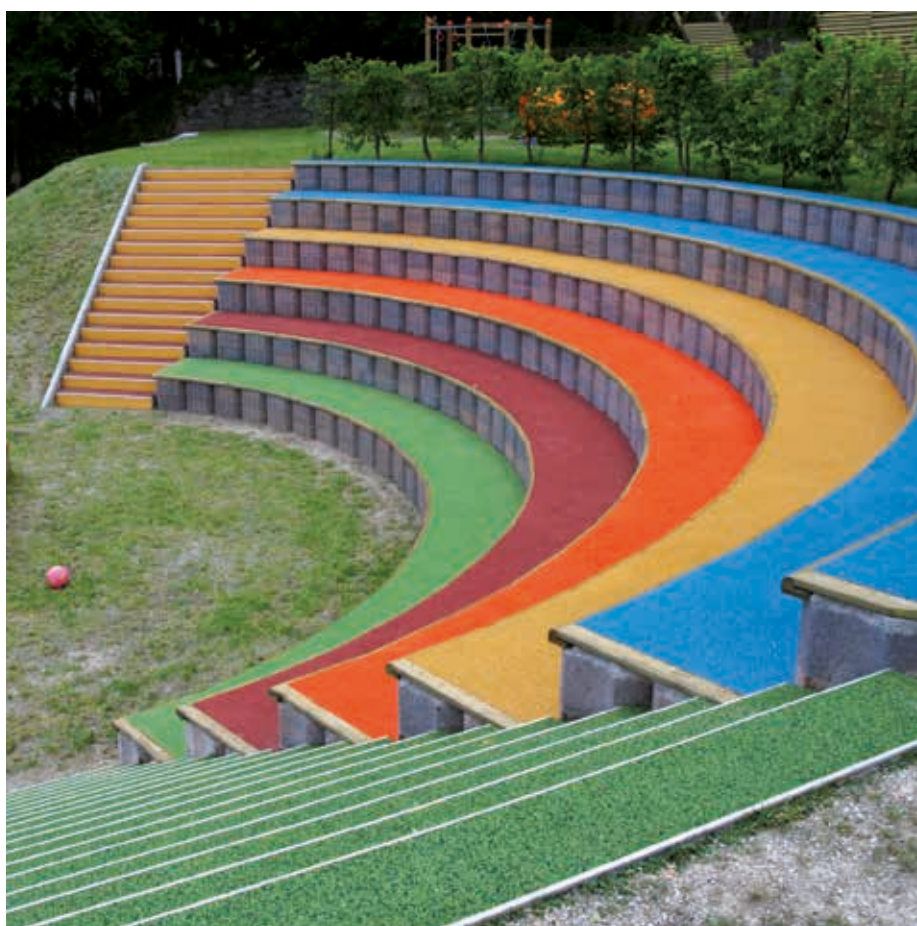
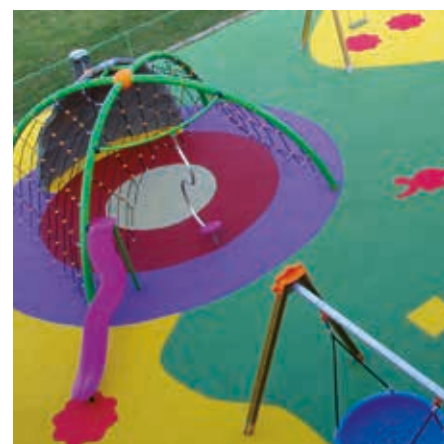

Pallet da 50 mq di gomma antitrauma spessore mm 30 per altezza caduta cm 100, dimensione cm 50x50



■ xp39



■ xp160

Pallet da 35 mq di gomma antitrauma spessore mm 45 per altezza caduta cm 150, dimensione cm 50x50



■ xp100



■ xp186



■ xp187

Pallet da 27 mq di gomma antitrauma spessore mm 65 per altezza caduta cm 200, dimensione cm 50x50



■ xp200



Pavimentazione a griglia

dimensione cm 100x100

Per rispettare lo HIC di caduta indicato la piastra grigliata deve essere riempita con substrato vegetale.

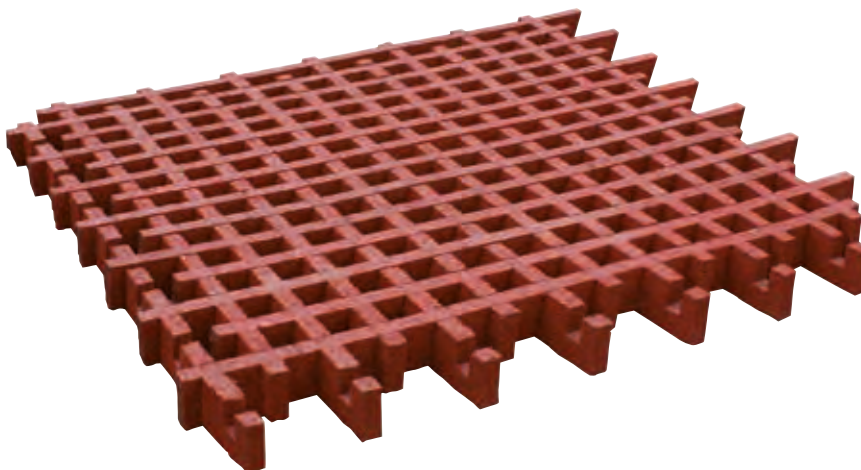

codice	spessore	alt. caduta
xp245	45 mm	150 cm
xp265	65 mm	210 cm

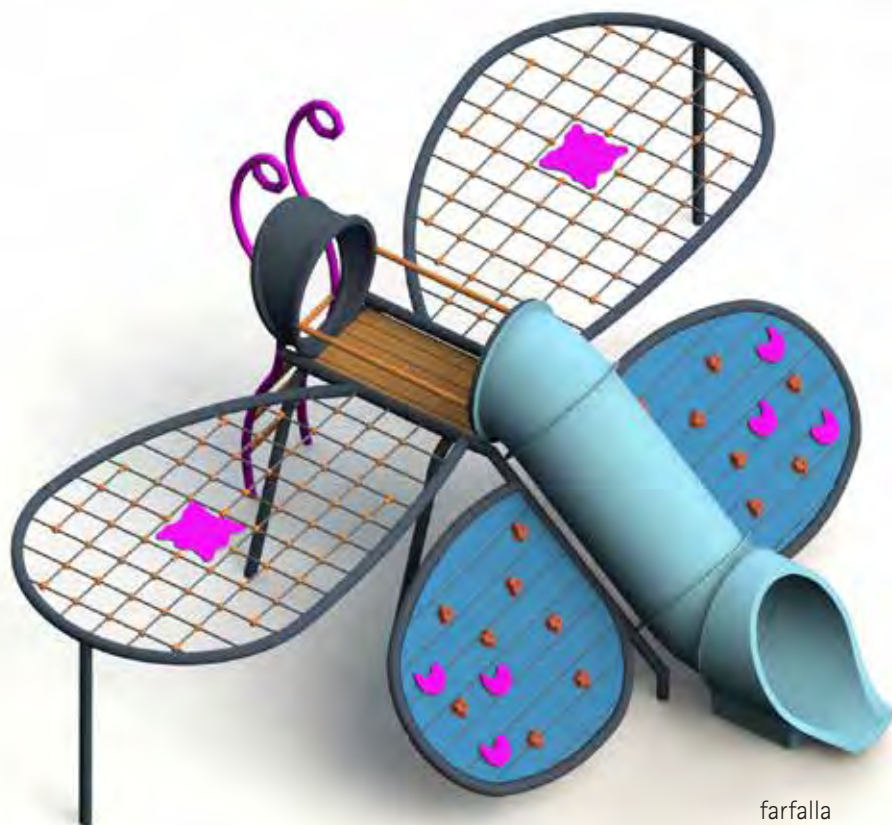

farfalla
xfy20

- 640x460, h 270 cm
- 150 cm
- 1030x850 cm
- > 3
- 62 m²

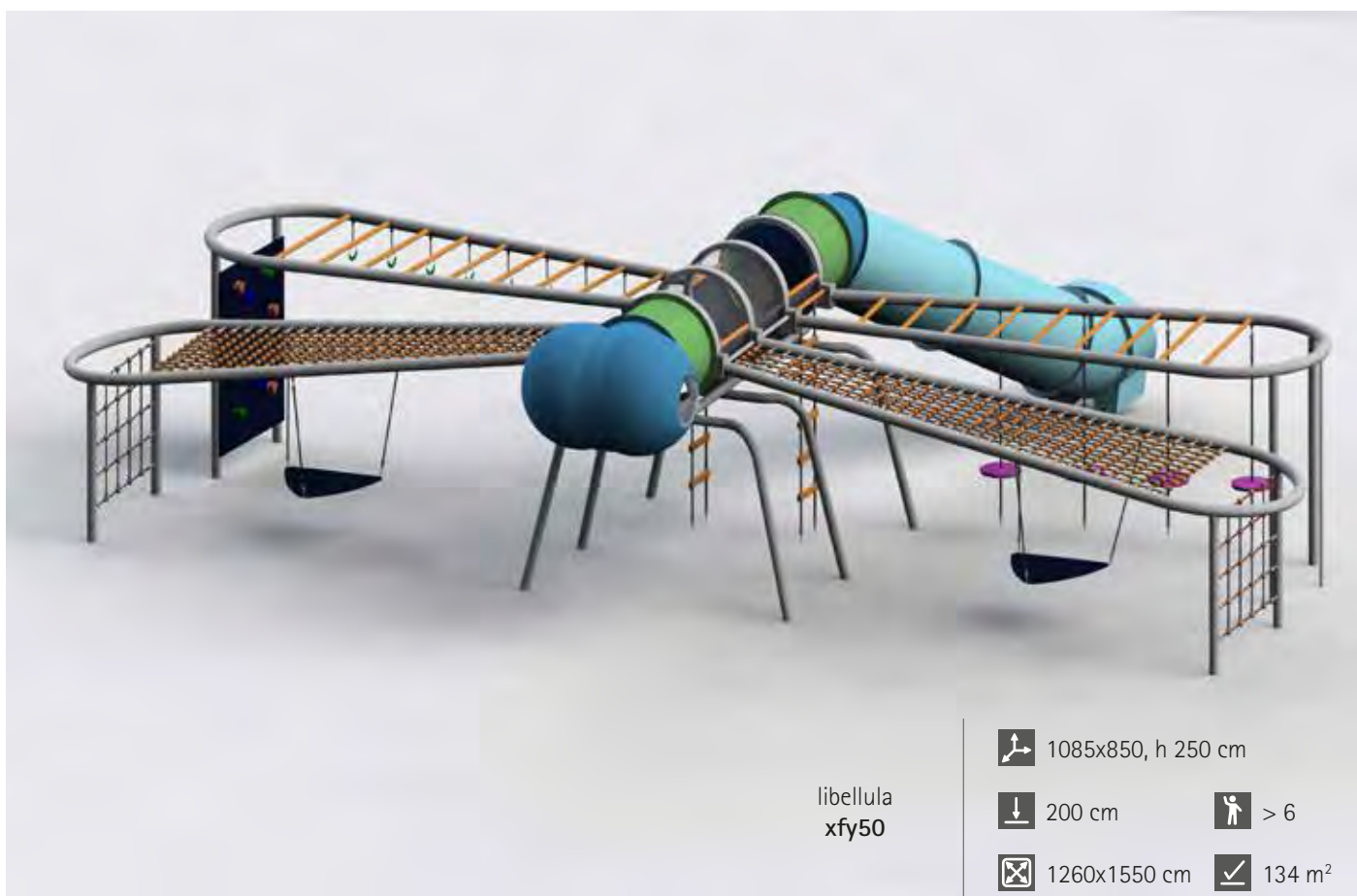

libellula
xfy50

- 1085x850, h 250 cm
- 200 cm
- 1260x1550 cm
- > 6
- 134 m²

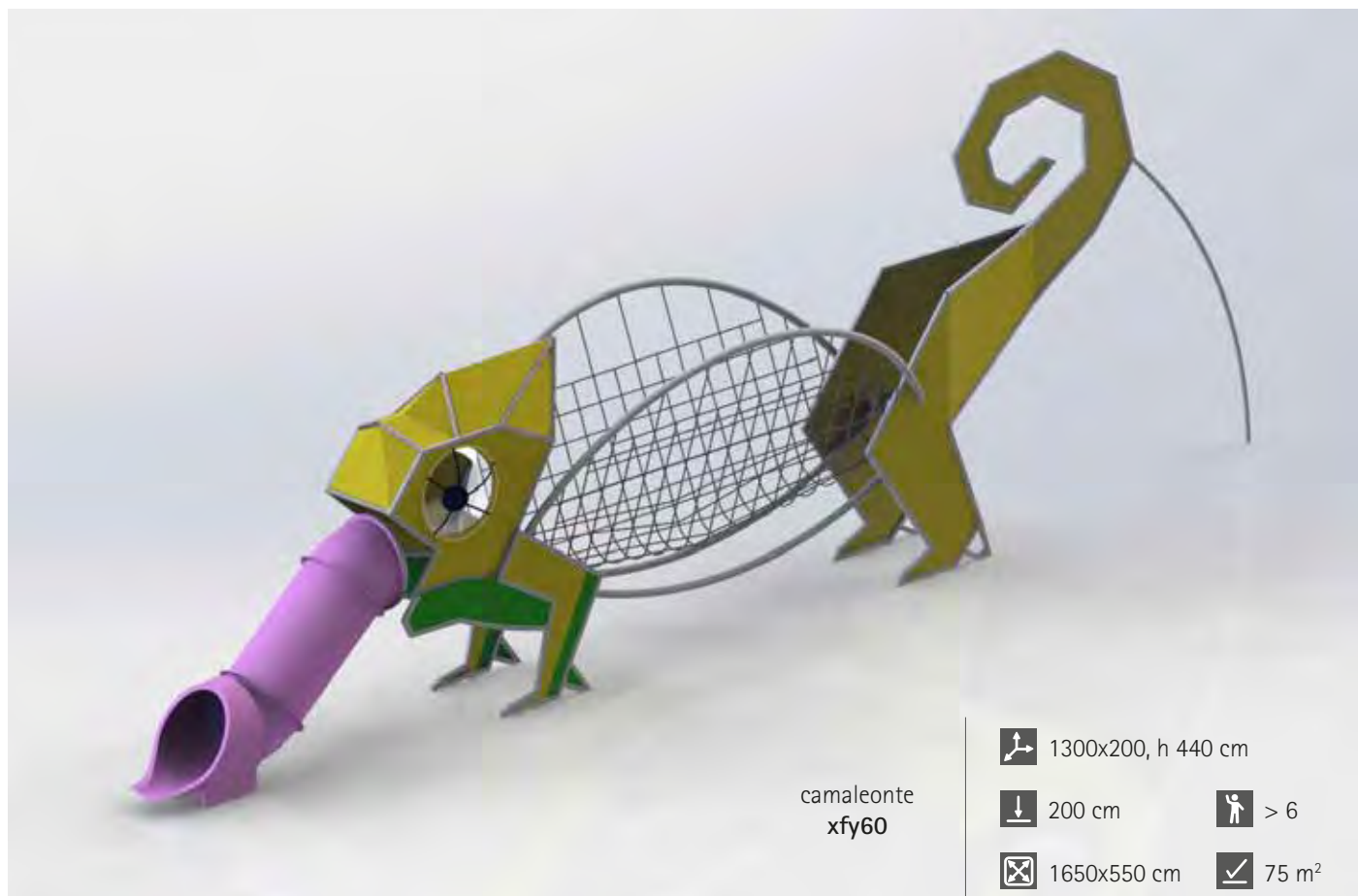



camaleonte
xfy60

 1300x200, h 440 cm

 200 cm

 > 6

 1650x550 cm

 75 m²

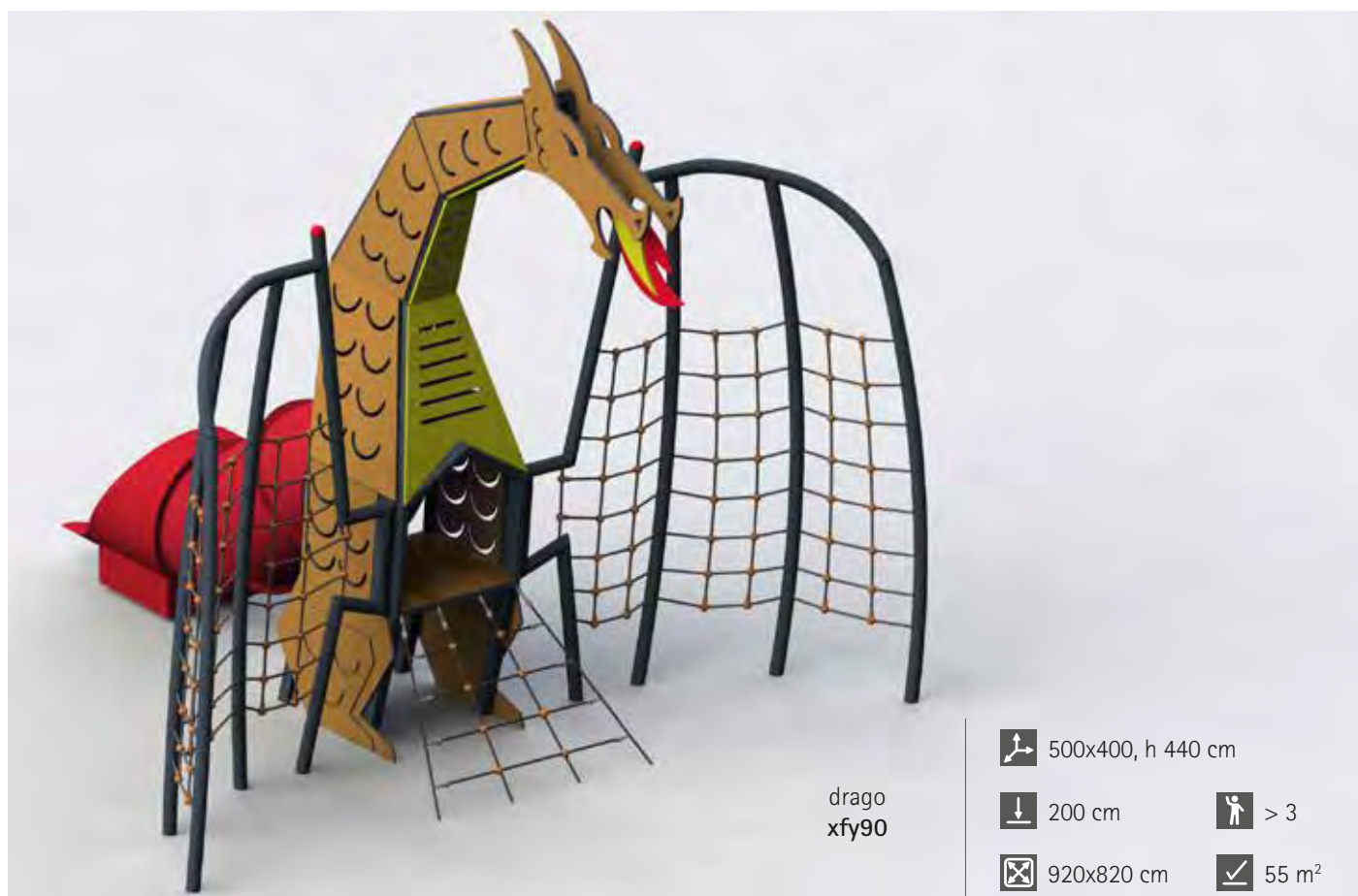



drago
xfy90

 500x400, h 440 cm

 200 cm

 > 3

 920x820 cm

 55 m²

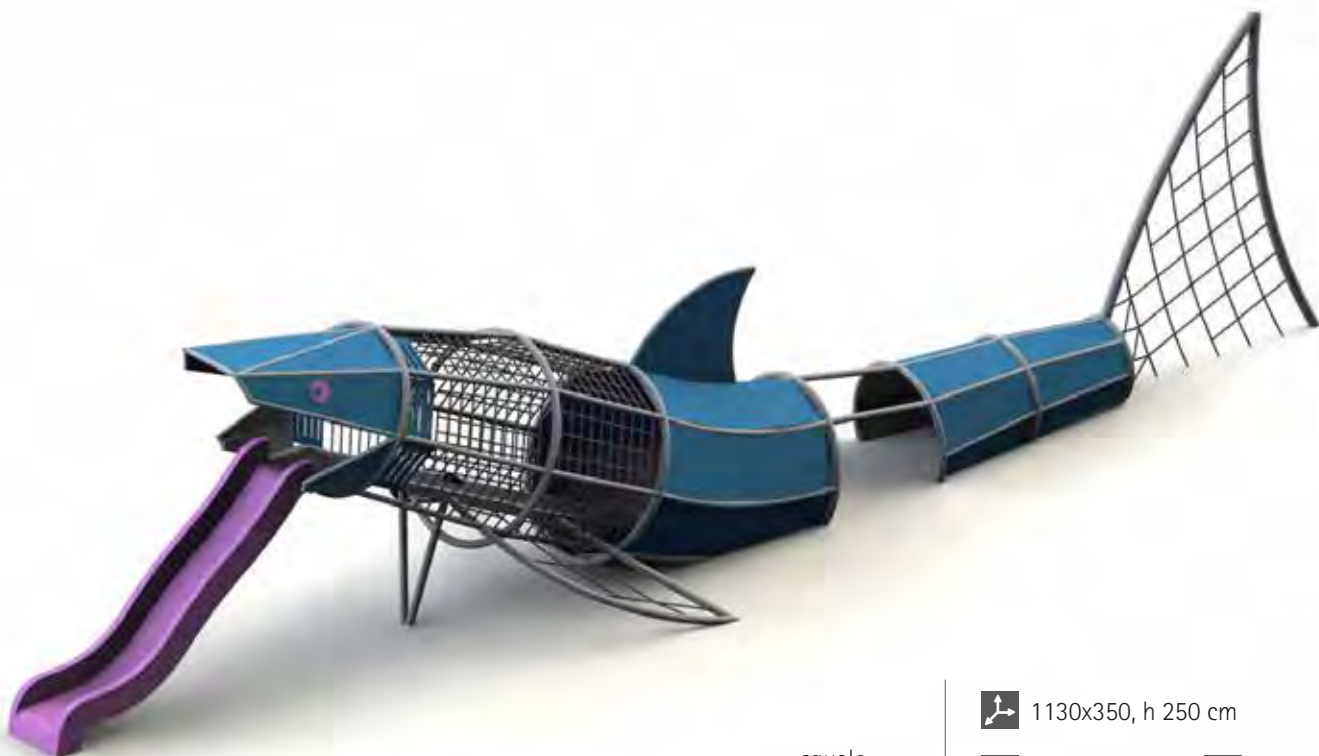

squalo
xfy30

- 1130x350, h 250 cm
- 250 cm
- 1580x650 cm
- > 3
- 75 m²

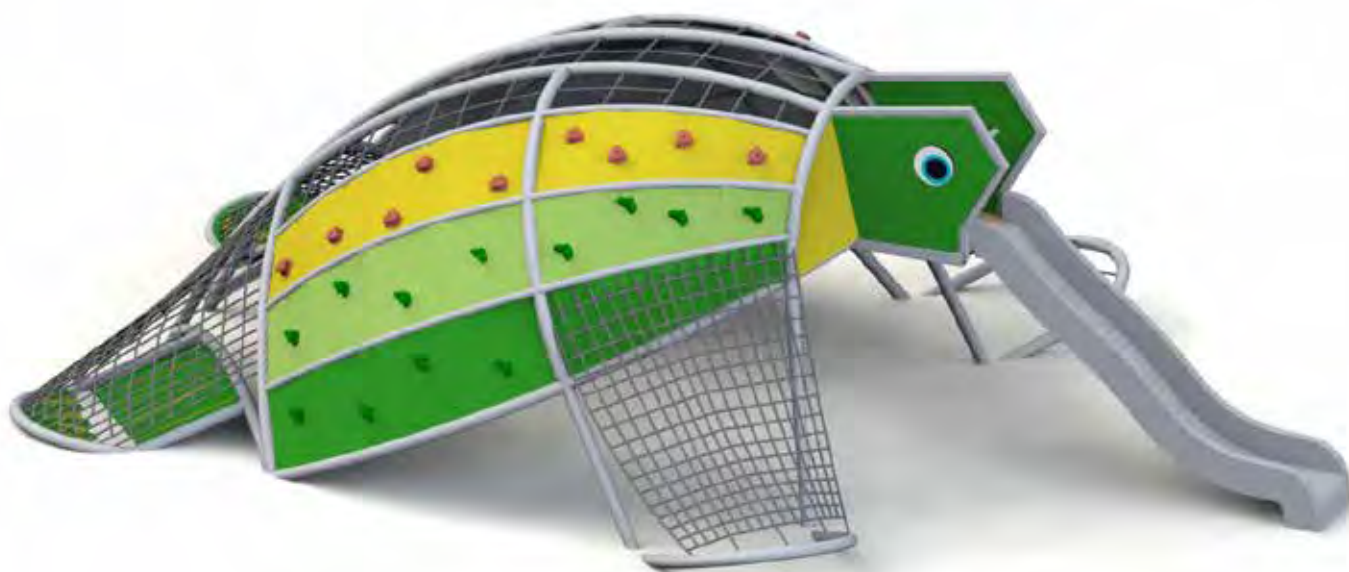



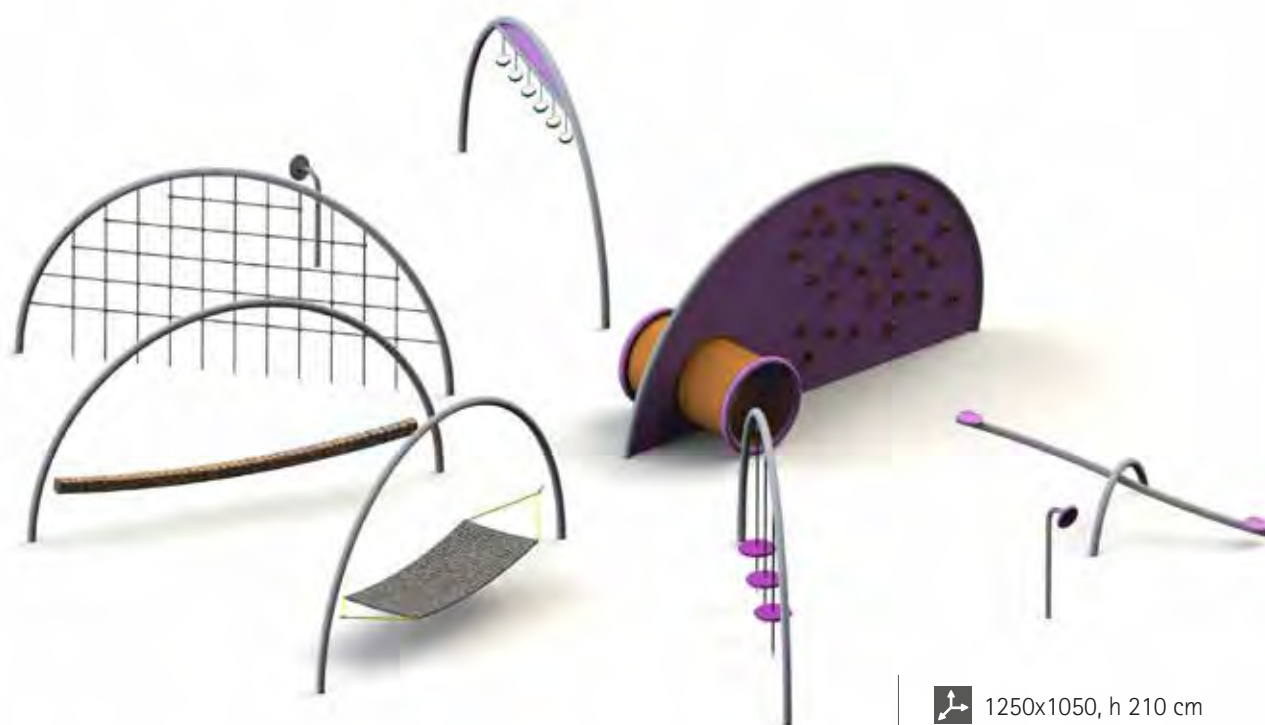

tartaruga
xfy10

- 800x600, h 220 cm
- 200 cm
- 1130x880 cm
- > 6
- 72 m²







polipo
xfy70

-  1250x1050, h 210 cm
-  200 cm  > 6
-  1450x1260 cm  120 m²



navicella
xfy40

-  700x500, h 490 cm
-  200 cm  > 6
-  1080x800 cm  65 m²

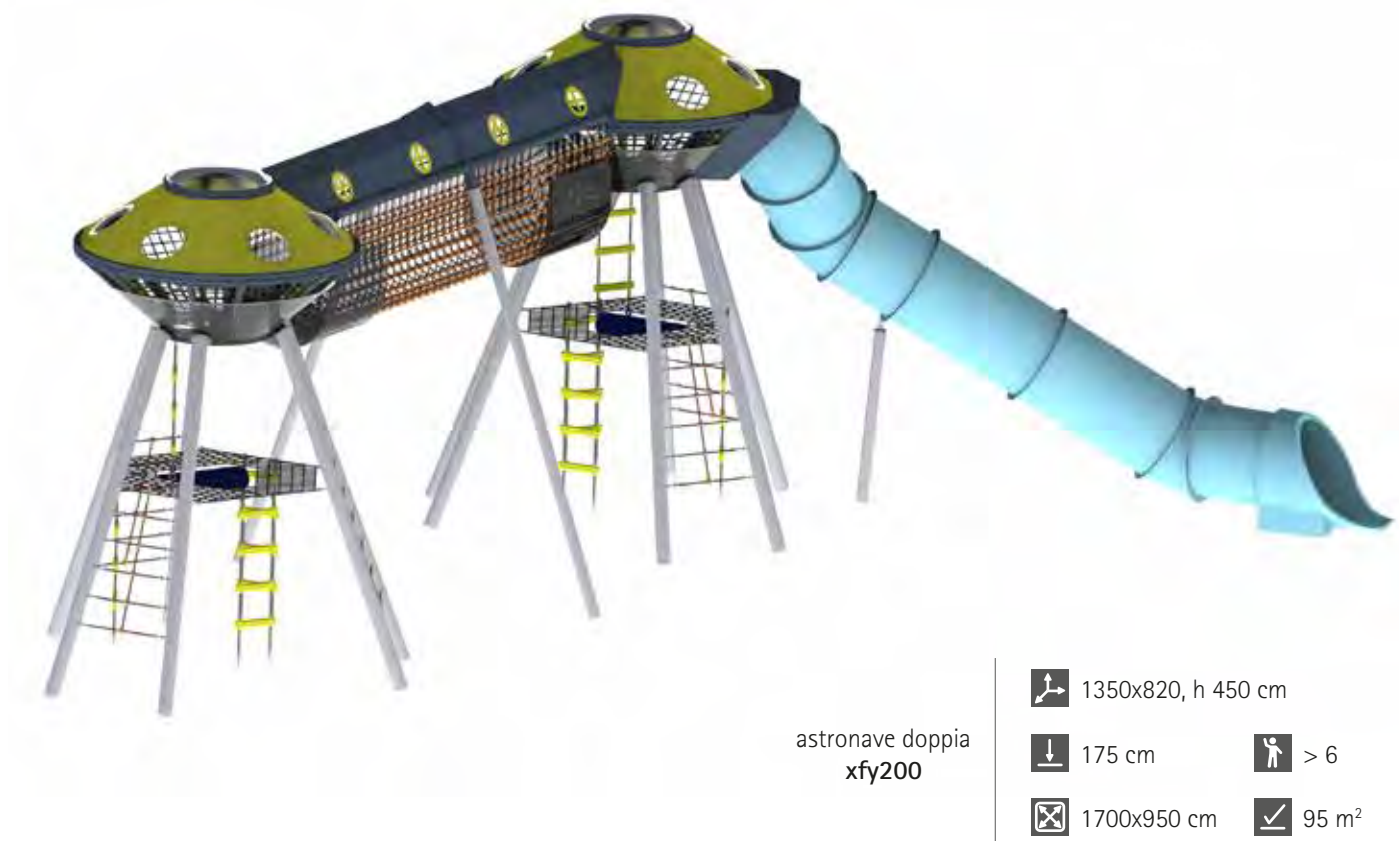

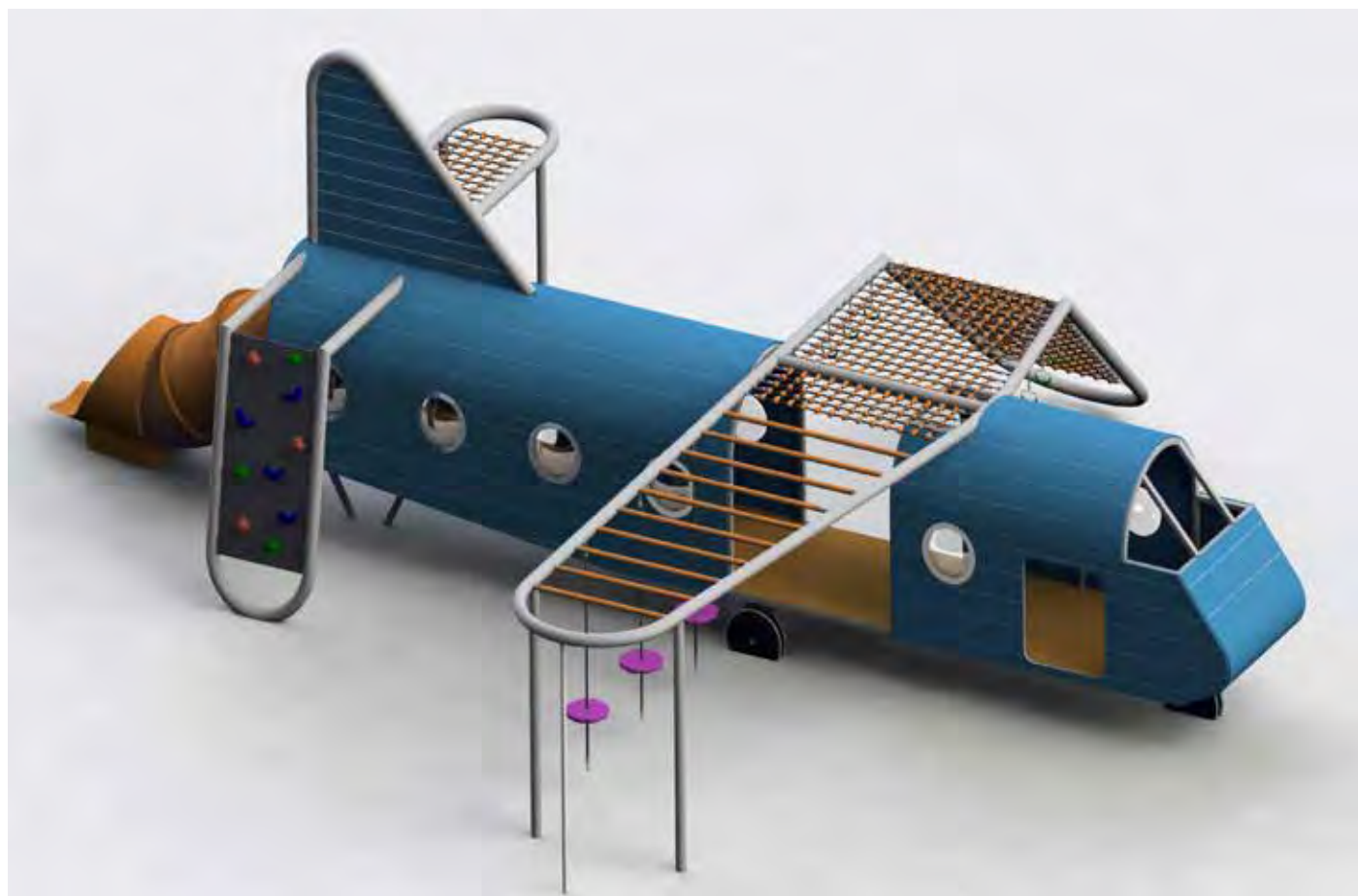

aereo
xfy80

📏 1090x930, h 350 cm

↓ 200 cm

👤 > 3

📐 1430x1250 cm

✅ 110 m²



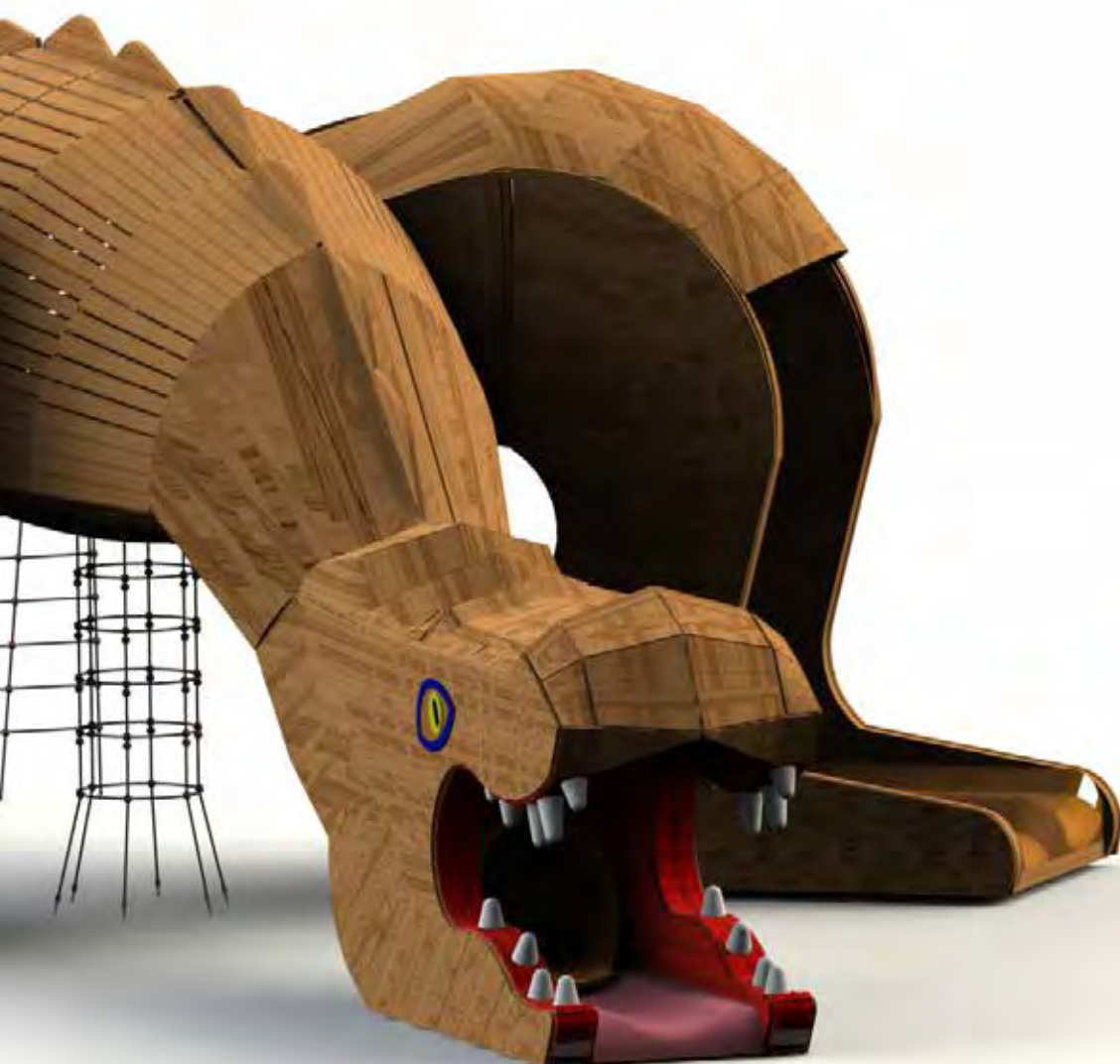

dinosauro
xfy800

1827x1067, h 477 cm

250 cm

> 6

2127x1367 cm

182 m²



profilo aziendale

Holzhof srl è da oltre 40 anni una delle aziende leader nella realizzazione di strutture per parchi gioco e per l'arredo urbano.

Holzhof ha realizzato moltissimi progetti sia per il settore pubblico che per quello privato e con la sua esperienza pluridecennale mette a disposizione dei propri clienti un servizio completo di consulenza, progettazione e produzione.

La nostra missione

Offriamo ad imprese private ed enti pubblici tutti i prodotti che servono a realizzare parchi gioco per bambini in aree pubbliche e private e gli accessori per arredare piazze, vie ed intere città.

Le nostre proposte sono sempre innovative, con soluzioni stabili e destinate a durare nel tempo.

La nostra affidabilità e le nostre certificazioni

Sin dal 1997 siamo in possesso della certificazione di qualità UNI EN ISO 9001 e, fedeli alla nostra filosofia Aziendale, ci impegniamo quotidianamente per rendere un servizio attivo a tutela dell'ambiente e quindi a preservare la natura, il bene comune dell'umanità.

Per queste ragioni abbiamo aderito anche alla normativa ambientale UNI EN ISO 14001. Holzhof è inoltre certificata secondo le norme UNI ISO 45001 per la Sicurezza e la Salute dei lavoratori.

La nostra azienda è in grado di marcare CE il legno massiccio ad uso strutturale secondo la UNI EN 14081-1 in vigore. Siamo in possesso anche dell'Attestato di Denuncia dell'Attività di Lavorazione di Elementi strutturali in legno massiccio e lamellare (Centro di Trasformazione).



Lavoriamo con riguardo

FSC® (Forest Stewardship Council) e PEFC™ (Programme for Endorsement of Forest Certification schemes) sono due sistemi di certificazione che permettono di rintracciare la provenienza del legname grezzo che noi lavoriamo, garantendo l'origine da foreste gestite in modo corretto dal punto di vista ambientale e sociale.

Lavoriamo rispettando la sicurezza degli utenti

Le nostre attrezzature per parchi gioco rispettano tutti i parametri stabiliti in materia di sicurezza, in conformità alle normative UNI EN 1176 in vigore. Garante per la sicurezza è il marchio GS, conferito dal prestigioso Ente Tüv-Product Service della Germania.

Il nostro orientamento è la qualità

La lavorazione ed il trattamento dei vari materiali garantiscono l'utilizzo del prodotto finito al massimo della sua qualità per molti anni.

In particolare, la protezione del legno è determinante per la longevità dello stesso, anche in caso di condizioni climatiche particolarmente avverse ed è per questa ragione che una parte del legno di pino da noi utilizzato viene impregnato in autoclave sottovuoto a pressione oppure subisce apposito trattamento termico (termo legno). Il legno di robinia invece può

essere tranquillamente utilizzato allo stato naturale per la realizzazione di strutture che devono essere collocate all'aperto, anche in considerazione del fatto che risulta essere l'unico legno europeo con classe di durabilità 1-2. (molto durabile-durabile)

I nostri impianti di produzione sono all'avanguardia e garantiscono precisione, efficienza e sicurezza durante il funzionamento e questi sono i migliori presupposti per ottenere la massima qualità. Superato il controllo finale, ciascuno dei prodotti Holzhof ottiene il nostro marchio di riconoscimento, che noi promuoviamo in linea con la nostra filosofia Aziendale.

Per tutti questi motivi le creazioni Holzhof sono da sempre sinonimo di alta qualità, prodotte nel rispetto dell'ambiente e fatte per durare negli anni, per soddisfare le esigenze degli utenti che nel nostro marchio riconoscono la garanzia principale della nostra affidabilità.

Polietilene

Holzhof da anni utilizza con entusiasmo e grandi risultati il polietilene per la realizzazione di gran parte dei componenti delle proprie attrezzature ludiche.

La grande lavorabilità e le ottime caratteristiche tipiche di questo materiale ci hanno permesso di creare una grande quantità di forme per lo stampaggio rotazionale, in particolare per elementi quali: scivoli, pedane di salita, tetti, parapetti, scalette, giochi a molla, pannelli attività, complementi di arredo ecc.

Il polietilene utilizzato da Holzhof, prodotto con procedimento rotazionale, viene sottoposto ad un trattamento di colorazione nella massa pertanto i suoi colori non stingono, resiste a temperature che variano da -85°C a $+90^{\circ}\text{C}$, ha un'elevata capacità di respingere i raggi UV ed è riciclabile al 100%.

Oltre a queste fondamentali caratteristiche, il polietilene si distingue da altri materiali anche per la buona resistenza all'usura e all'abrasione, nonché all'urto, per il basso coefficiente di attrito e lo scarso assorbimento d'acqua, per le eccellenti proprietà di antiaderenza e per il basso peso specifico, che consente un forte risparmio durante le fasi di trasporto e montaggio dei prodotti realizzati con esso.

Legname

Il legname che Holzhof utilizza, sia nella versione squadrata che in quella tonda, proviene prevalentemente da foreste certificate, la maggior parte delle quali è situata nel nord della Svezia.

Il legno viene trattato direttamente presso il nostro stabilimento con tecniche d'impregnazione in autoclave con metodo sottovuoto pressione soltanto al termine di tutte le altre possibili operazioni, quali ad esempio il taglio o la lavorazione del pezzo.

Solamente in questo modo, infatti, il trattamento a base di sali idrosolubili si impregna omogeneamente nella materia, rendendola - anche grazie ai prodotti di alta qualità da noi utilizzati - estremamente resistente alle aggressioni climatiche e/o parassitarie, preservandone a lungo le caratteristiche qualitative.

L'impregnazione viene eseguita secondo quanto prescritto dalla normativa europea vigente in materia, la UNI EN 351-1.

Alluminio

L'alluminio è un metallo leggero difficilmente ossidabile. Holzhof utilizza profili realizzati per estrusione a freddo in lega di alluminio EN A W - 6060 (conforme alle normative europee vigenti in materia), poi verniciati con polveri epossidiche atossiche.

Tra i numerosi vantaggi che questo tipo di metallo comporta, possiamo annoverare in particolare la sua leggerezza, dato che a parità di volume l'alluminio pesa solamente un terzo dell'acciaio.

Grazie all'alluminio si possono ottenere risparmi di peso significativi in quasi ogni tipo di applicazione meccanica. Oltre a ciò, suddetto metallo è molto apprezzato per la facilità con la quale può essere riciclato, consentendo una maggiore tutela delle risorse ambientali, tematica - questa - che Holzhof ha sempre particolarmente a cuore.

Quasi un terzo dell'alluminio consumato in tutto il mondo ai giorni nostri viene prodotto riciclando rottami.





HOLZHOF® 

Follow us on



Via della Rupe, 33
I-38017 Mezzolombardo -TN

Tel +39 0461 601 501
Fax +39 0461 604 013

www.holzhof.com
info@holzhof.com

Materiali conformi al decreto CAM (Criteri Ambientali Minimi)
per arredo urbano e giochi per parchi:
robinia certificata, alluminio e polietilene riciclato